



# Frontier™ 5515 & 5515R

High-Speed Microliter Centrifuges



## **Smooth and Dependable High-Speed Microliter Centrifuge for Liquid Separation Applications**

Frontier 5515 and 5515R microliter benchtop centrifuges provide high-speed operation for spin-down applications requiring a wide variety of tube volumes and capacities. With refrigeration capabilities (FC5515R), 10 acceleration/deceleration settings, multiple safety features, and an unmatched capacity, Frontier provides stable liquid separation for applications requiring high-speed operation.

### **Standard Features Include:**

- **Easy-to-Use Control Panel that Supports Simple Operation**—The intuitive control panel with rotary knob puts the centrifuge's simple operations at your fingertips, including the ability to set and recall speed and g-force, as well as control the temperature (FC5515R only).
- **Sophisticated Technology that Drives High-Performance**—A powerful brushless induction motor, 10 acceleration and deceleration settings, and memory for up to 99 commonly-used parameters are a few of Frontier's features that propel high-performance.
- **Safety Features that Protect Against Injury**—Among Frontier's safety attributes are a motorized lid locking system and a rotor imbalance sensor that stops the centrifuge if the rotors become imbalanced or sudden shock occurs, protecting the operator from the high-speed spinning rotors.
- **Seven Rotor Sizes that Provide Flexibility for Varied Centrifugation Needs**—Compatible with seven different rotors, more than any centrifuge in its class, the highly-versatile Frontier can be used for various applications of different volumes.

# Frontier™ 5515 & 5515R High-speed Microliter Centrifuges

## Easy-to-Use Control Panel

- Easy-to-turn rotary knob for parameter adjustments
- Waterproof keypad provides protection that helps significantly increase the lifespan of the product
- One-touch toggling between speed, g-force, and temperature controls (R model only)
- LCD display which projects information in real-time
- View and adjust user parameters from the main screen; no need to navigate through sub-screens



## High-Performance Driven by Sophisticated Technology

- Powerful induction motor reaches speeds up to 15,200 RPM in less than 16 seconds
- Maximum g-force of 21,953 RCF
- 10 acceleration/deceleration settings
- 99 memory sets for commonly-used speed, time, and temperature settings (R Model Only)
- R model has refrigeration capabilities from 40°C to -20°C
  - Cools down from 23°C to 4°C in less than 10 minutes
  - Pre-cool feature quickly lowers the temperature of rotor and chamber before a run

## Dimensions

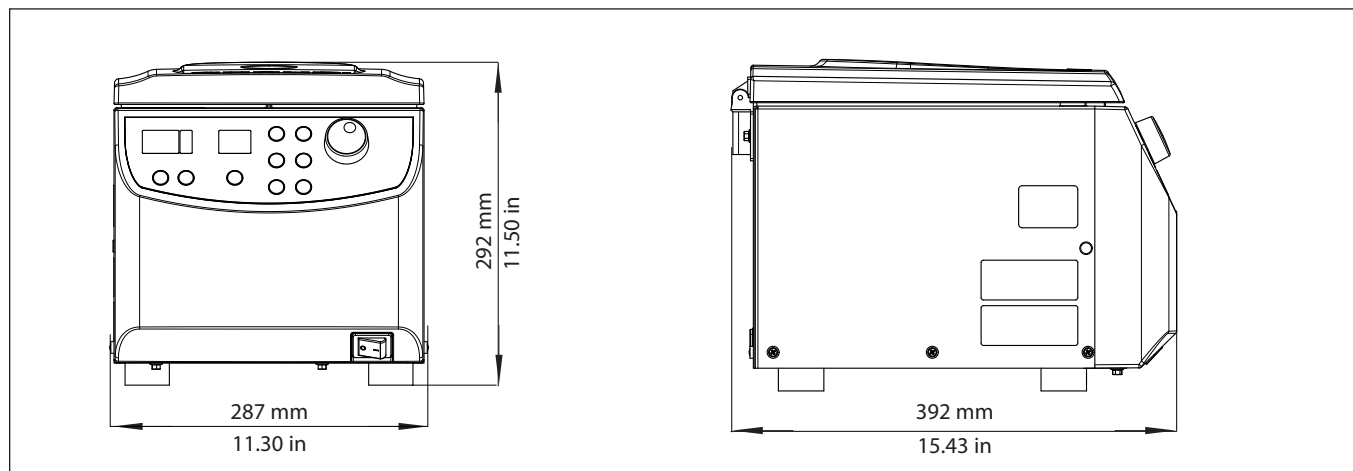

Frontier 5515

## Safety Features that Prevent Injury

- Motorized lid-locking system prevents centrifuge from opening during operation
- Rotor imbalance sensing system stops the motor should the rotors become imbalanced, protecting the user from spinning rotors



## Flexibility for Varied Centrifugation Needs

- Maximum capacity of 44 × 1.5/2 mL and 12 × 5 mL tubes
- Only centrifuge in its class compatible with 6 rotors (7 rotors on 5515 model), including a PCR strip tube rotor
- The most economical centrifuge on the market to include a unique 5 mL tube rotor
- The signature snap-on rotor and lid locking system allows for quick installation of rotors with just one press of a button



## Dimensions

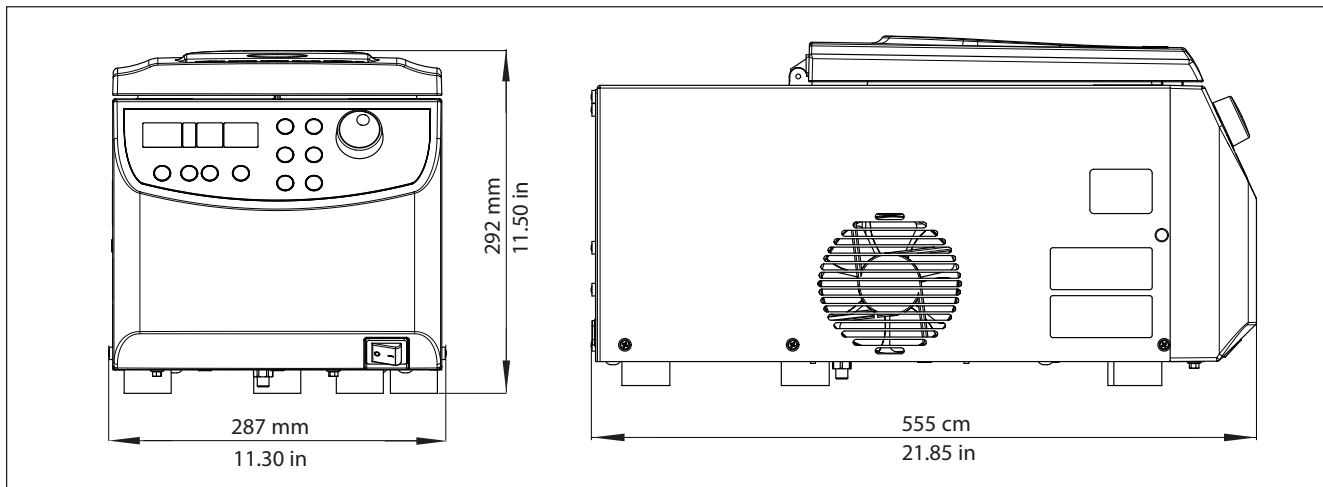

**Frontier 5515R**

# Frontier™ 5515 & 5515R High-speed Microliter Centrifuges

Model	FC5515R		FC5515	
Speed Range	200 rpm - 15200 rpm; 10 rpm/increments		200 rpm - 15200 rpm; 10 rpm/increments	
Maximum RCF	21953 × g; 10 × g/set		21953 × g; 10 × g/set	
Maximum Capacity (Rotor)	44 × 1.5/2.0mL; 12 × 5mL		44 × 1.5/2.0mL; 12 × 5mL	
Temperature Range/Cooling	-20° to 40°C, 1°C/set		Air cooled	
Running Time	10sec to 99hr 99min 59sec or continuous		10sec to 99hr 99min 59sec or continuous	
Noise Level (Varies by Rotor)	≤ 57 + 2 dB(A)		≤ 60 + 2 dB(A)	
AC Power	230 V/50 - 60 Hz	120 V/50 - 60 Hz	230 V/50-60 Hz	120 V/50-60 Hz
Fluctuation	± 10%	± 10%	± 10%	± 10%
Current Consumption	2.4 A	5.1 A	1.3 A	2.3 A
Power Consumption	500 W	560 W	270 W	280 W
Dimensions (W × D × H)	11.3 × 22.1 × 11.5 in/287 × 561 × 292 mm		11.3 × 15.5 × 11.5 in/287 × 393 × 292 mm	
Net Weight (Without Rotor)	77 lb/35 kg		38 lb/17 kg	
Shipping Dimensions (W × D × H)	15.7 × 26.0 × 20.5 in/400 × 660 × 520 mm		15.7 × 21.5 × 16.1 in/400 × 545 × 410 mm	
Shipping Weight (Without Rotor)	97 lb/44 kg		44 lb/20 kg	

## Approvals



- **Product Safety:** EN 61010-1:2010, EN 61010-2-020:2006
- **Electromagnetic Compatibility:** EN 61326-1:2006, FCC Part 15 Class B

# Frontier™ 5515 & 5515R Rotors and Adapters



## ***Rotors and Adapters that Expand the Versatility of the Frontier FC5515 Series***



A variety of rotors and tube adapters can be used in conjunction with the Frontier FC5515 Series, providing centrifugation for samples of various sizes

				
Item	Angle Rotor, 24 × 1.5/2.0 mL	0.5 mL Tube Adapter	0.4/0.2 mL Tube Adapter	
Item Number	30130870	30130885	30130884	
Compatible Tubes	1.5 mL and 2.0 mL	0.5 mL	0.4 mL	0.2 mL
Maximum Number of Tubes	24	24	24	24
Max. RPM	15200 rpm	15200 rpm	15200 rpm	
Max. RCF	21953 × g	19112 × g	21178 × g	17562 × g
Radius	3.35 in/85 mm	2.91 in/74 mm	3.23 in/82 mm	2.68 in/68 mm
Type	Angle Rotor ∠45°	—		
Lid/Lid Material/Rotor Material	Snap-on/PEI <sup>2</sup> /Aluminium	—		
Lowest refrigerated temperature in FC5515R <sup>1</sup>	+6 °C			

# Frontier™ 5515 & 5515R Rotors and Adapters

				
Item	Angle Rotor, 24 × 1.5/2.0 mL, Biocontainment	0.5 mL Tube Adapter	0.4/0.2 mL Tube Adapter	
Item Number	30130871	30130885	30130884	
Compatible Tubes	1.5 mL and 2.0 mL	0.5 mL	0.4 mL	0.2 mL
Maximum Number of Tubes	24	24	24	24
Max. RPM	15200 rpm	15200 rpm	15200 rpm	
Max. RCF	21953 × g	19112 × g	21178 × g	17562 × g
Radius	3.35 in/85 mm	2.91 in/74 mm	3.23 in/82 mm	2.68 in/68 mm
Type	Angle Rotor ∠45°	—		
Lid/Lid Material/Rotor Material	Aerosol Tight/Aluminium/Aluminium	—		
Lowest refrigerated temperature in FC5515R <sup>1</sup>	+4°C			

				
Item	Angle Rotor, 30 × 1.5/2.0 mL, Biocontainment	0.5 mL Tube Adapter	0.4/0.2 mL Tube Adapter	
Item Number	30130872	30130885	30130884	
Compatible Tubes	1.5 mL and 2.0 mL	0.5 mL	0.4 mL	0.2 mL
Maximum Number of Tubes	30	30	30	30
Max. RPM	13500 rpm	13500 rpm	13500 rpm	
Max. RCF	19150 × g	17113 × g	18539 × g	15687 × g
Radius	3.70 in/94 mm	3.31 in/84 mm	3.58 in/91 mm	3.03 in/77 mm
Type	Angle Rotor ∠45°	—		
Lid/Lid Material/Rotor Material	Aerosol Tight/PC <sup>3</sup> /Aluminium	—		
Lowest refrigerated temperature in FC5515R <sup>1</sup>	+7 °C			

				
Item	Angle Rotor, 44 × 1.5/2.0 mL	0.5 mL Tube Adapter	0.4/0.2 mL Tube Adapter	
Item Number	30130879	30130885	30130884	
Compatible Tubes	1.5 mL and 2.0 mL	0.5 mL	0.4 mL	0.2 mL
Maximum Number of Tubes	44	44	44	44
Max. RPM	13500 rpm	13500 rpm	13500 rpm	
Max. RCF	17113 × g / 17317 × g	14872 × g / 15687 × g	16705 × g / 16909 × g	13446 × g / 14872 × g
Radius	3.30 in/84mm 3.34 in/85mm	2.87 in/73mm 3.03 in/77mm	3.22 in/82mm 3.26 in/83mm	2.59 in/66mm 2.87 in/73mm
Type	Angle Rotor ∠32°/55°	—		
Lid/Lid Material/Rotor Material	Snap-on/PP <sup>4</sup> /Aluminium	—		
Lowest refrigerated temperature in FC5515R <sup>1</sup>	+7 °C			

				
Item	Angle rotor, 12 × 5 mL, biocontainment	1.5 mL/2.0 mL Tube Adapter	1.8 mL Cryo Tube Adapter	1.0 mL Cryo Tube Adapter
Item Number	30130873	30130886	30130888	30130887
Compatible Tubes	5.0 mL	1.5 mL/2.0 mL	1.8 mL	1.0 mL
Maximum Number of Tubes	12	12	12	12
Max. RPM	14500 rpm	14500 rpm	14500 rpm	14500 rpm
Max. RCF	19978 × g	16687 × g	17627 × g	16217 × g
Radius	3.35 in/85 mm	2.80 in/71 mm	2.80 in/61 mm	2.72 in/69 mm
Type	Angle Rotor ∠45°	—		
Lid/Lid Material/Rotor Material	Aerosol Tight/Aluminium/Aluminium	—		
Lowest refrigerated temperature in FC5515R <sup>1</sup>	+4 °C			

# Frontier™ 5515 & 5515R Rotors and Adapters

	
Item	Angle rotor, 4 x 8-Place PCR Stripes
Item Number	30130874
Compatible Tubes	0.2 mL PCR 8-strips
Maximum Number of Tubes	4 x 8-place strips
Max. RPM	15000 rpm
Max. RCF	15342 x g
Radius	2.40 in/61 mm
Type	Angle Rotor $\angle 45^\circ$
Lid/Lid Material/Rotor Material	Screw/PC <sup>3</sup> /PP <sup>4</sup>
Lowest refrigerated temperature in FC5515R <sup>1</sup>	+2.5°C

	
Item	Hematocrit rotor, 24 x Capillaries
Item Number	30130881
Compatible Model	FC5515
Compatible Tubes	Capillaries
Maximum Number of Tubes	24
Max. RPM	12000 rpm
Max. RCF	14970 x g
Radius	3.66 in/93 mm
Type	Angle Rotor $\angle 90^\circ$
Lid/Lid Material/Rotor Material	Snap-on/Aluminium/Aluminium

## Notes:

1. At room temperature of 23 °C. This is the lowest attainable temperature at which the pre-cooled, refrigerated centrifuge spins at maximum speed with a full load. Lower temperatures can be attained by reducing the speed, number of samples or room temperature.
2. PEI: Polyetherimide
3. PC: Polycarbonate
4. PP: Polypropylene

**OHAUS CORPORATION**  
 \*7 Campus Drive  
 Suite 310  
 Parsippany, NJ 07054 USA  
 Tel: 800.672.7722  
 973.377.9000  
 Fax: 973.944.7177

**www.ohaus.com**  
 With offices throughout  
 Europe, Asia, and  
 Latin America

**\*ISO 9001:2008**  
 Registered Quality  
 Management System

