



Laboratory Equipment Manufacturer
www.mrclab.com



Operation Manual for Milk Analyzer

MIA-LA



PLEASE READ THIS MANUAL CAREFULLY BEFORE OPERATION

3, Hagavish st. Israel 58817 Tel: 972 3 5595252, Fax: 972 3 5594529 mrc@mrclab.com

MRC.VER.01-10.12

Switching Adapter

- **Input:** 100 - 240 V ~1.6 A max.
50-60 Hz
- **Output:** +12 V \equiv 4.17A min.
- **Output power:** 50 - 65 W

Measurement modes

- cow milk
- sheep milk
- UHT milk
- goat milk
- buffalo milk
- cream
- whey
- recovered milk
- other /pasteurized milk/



CAUTION!

Keep the switching adapter dry!
Please, read and follow strictly all the instructions in the manual.

Due to continuous improvement in milk analyser, information contained in this manual is subject to change without notice. Contact producer for revisions and corrections



MRC LTD -HAGAVISH 3, HOLON ISRAEL
Tel: 972-3-5595252, Fax: 972-3-5594529
E-mail: mrc@mrclab.com • Web. Site: www.mrclab.com

SAFETY INSTRUCTIONS

- 1. Read this manual carefully and make sure that you understand all the instructions.**
- 2. For safety purposes the device is equipped with grounded power cable. If there is no grounded electrical outlet where the device will be used, please, install such before using the device.**
- 3. Place the device on leveled and stable plate. In case it falls or is severely shocked it may be damaged.**
- 4. Connect to the electrical network in such a way that the power cable to stay away from the side for accessing the device and not to be stepped on.**
- 5. Every time before cleaning the device switch it off and unplug it from the electrical outlet. The device has to remain unplugged till the cleaning completion.**
- 6. Do not disassemble the unit in order to avoid possible electrical shock. In case of malfunction contact your local dealer.**
- 7. Handle the liquids the device works with carefully, following all the instructions for their preparation.**
- 8. Place the switching adaptor in such a way as to be protected from overflow and spillage of liquids.**



PARTS AND ACCESSORIES

In the table below the standard delivery configuration of the milk analyser is listed:

No	Description	Item No	pcs
1.	Ultrasonic portable milk analyzer	LSLA001	1
1 sample measurement time		90 sec.	<input type="checkbox"/>
		60 sec	<input type="checkbox"/>
		30 sec	<input type="checkbox"/>
2.	Operation manual	LSLA002	1
3.	Plastic sample holder	LSLA003	2
4.	Spare Pipes	LSLA004	2
5.	12 V DC Power Supply Cable	LSLA005	1
6.	Alkaline cleaning solution Lactodaily	100 g	1
7.	Acidic cleaning solution Lactoweekly	100 g	1

In the table below the milk analyser spares and accessories, which are delivered on customers' request are listed:

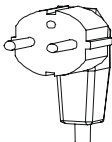
No	Description	Item No	pcs	<input checked="" type="checkbox"/>
	a) included in the set: <input checked="" type="checkbox"/>			/
	b) not included in the set (may be additionally bought): <input type="checkbox"/>			<input type="checkbox"/>
8.	RS232 Interface Cable - Analyser-IBM PC	LSLA006		<input type="checkbox"/>
9.	Service Pack - CD	LSLA007		<input type="checkbox"/>
10.	pH measuring system	LSLAS009	1	<input type="checkbox"/>
11.	pH probe with cable and holder	LSLA010	1	<input type="checkbox"/>
12.	Buffer solution Ph 60 ml (pH7.00±0.01/20°C)	LSLA011	1	<input type="checkbox"/>
13.	Buffer solution pH 60 ml (pH4.00±0.01/20°C)	LSLA012	1	<input type="checkbox"/>
14.	Milk conductivity measuring system	LSLA013	1	<input type="checkbox"/>
15.	Buffer solution conductivity 50 ml (5.02 (±5%) mS/cm (18±0.1°C)	LSLA014	1	<input type="checkbox"/>
16.	Real time clock	LSLA015	1	<input type="checkbox"/>
17.	High-fat measuring function	LSLA016	1	<input type="checkbox"/>

18.	ECS POS Serial Printer	LSLA017	1	<input type="checkbox"/>
19.	12 V Serial Printer Power Supply Cable	LSLA018	1	<input type="checkbox"/>
20.	RS232 Interface Cable - Milk Analyser – Serial Printer	LSLA019	1	<input type="checkbox"/>
21.	Power supply from embedded accumulator with charger	LSLA021	1	<input type="checkbox"/>
22.	Plug type		1	<input checked="" type="checkbox"/>
			1	<input type="checkbox"/>

1. FUNCTION

The function of the milk analyser is to make quick analyses of milk on fat (FAT), non-fat solids (SNF), proteins, lactose and water content percentages, temperature (°C), pH, freezing point, salts, conductivity as well as density of one and the same sample directly after milking, at collecting and during processing.

2. TECHNICAL PARAMETERS

2.1. Working modes characteristics:

The program of the milk analyser has four working modes.

2.1.1. Measurement mode milk / dairy product – first type

2.1.2. Measurement mode milk / dairy product – second type

2.1.3. Measurement mode milk / dairy product – third type

These modes have been calibrated on customers' request for 3 milk types from the following: cow, sheep, UHT, buffalo, goat, camel milk, cream, ice cream mixtures, whey, recovered milk, etc. before leaving the production facilities and the text on the display will be for the corresponding types, as is indicated on page 2 Measurement modes.

2.1.4. Cleaning

2.1.4.1. Current

2.1.4.2. Final

2.2. Measuring range:

Fatfrom 0.01% to 25% (45%*)
SNFfrom 3% to 40%
Density **from 1000 to 1160 kg/m ³
Proteinsfrom 2% to 15%
Lactosefrom 0.01 % to 20 %
Water contentfrom 0 % to 70 %
Temperature of milk	from 5oC to 40oC (if measurement is 30 sec, then t° is from 15 to 40°)
Freezing point ****from – 0,400 to – 0,700oC
Saltsfrom 0,4 to 4%
PH***from 0 to 14
Conductivity**from 2 to 14 [mS/cm]

* Option, on customers' request

** Density data are shown in an abbreviated form. For example 27.3 have to be understood as 1027.3 kg/m³. To determine the milk density, write down the result from the display and add 1000.

Example: result 21,20; density = 1000 + 31,20 = 1031,2 kg/m³

The abbreviated form of the density is used also when entering data for samples in working mode **Recalibrate**, for example:

If the measured sample density is 1034.5 kg/m³, then in the menu for entering the samples parameters used for calibration, across the parameter Den = , you have to enter 34.5.

*** pH and conductivity measurements are optional and are embedded in the device on customers' request.

**** Please, carefully read Appendix Freezing Point.

2.3. Accuracy:

Fat± 0.06%
SNF± 0.15%
Density± 0.3 kg/m ³
Proteins± 0.15%
Lactose± 0.20%
Water content± 3.0%
Temperature of milk± 1°C
Freezing point.....± 0.005°C
Salts± 0.05%
PH**±0.05
Conductivity**±0.05[mS/cm]



Accuracy values in point 2.3 are in dependence on the correctness of the corresponding chemical method, used for component content determination. In point 2.3. are used the following reference methods: Gerber – for fat, gravimetric – for SNF, Kjeldahl – for protein. The boundary for maximum variation of repeatability when the power supply voltage is from +10 to – 15% from the nominal voltage values (220V) have to be no more than 0.8 accuracy according point 2.3. The analyser is used in conditions free of outer electrical and magnetic fields (except the magnetic field of the Earth) and vibrations.

2.4 Correct ambient conditions:

Accuracy is guaranteed in case of normal ambient conditions:

Air temperature.....from 10°C to 40°C (43 °C)
Relative humidityfrom 30% to 80%
Power supply220V (110V)
extent of contamination at normal environmental conditions.....2

2.5. Dimensions:.....250/290/300 mm, mass 4,0 kg

2.6. Continuous working time:

.....non-stop

2.7 Milk sample volume per one measurement:

.....15 cm³ (= 15 ml)

Fig.1 Front panel

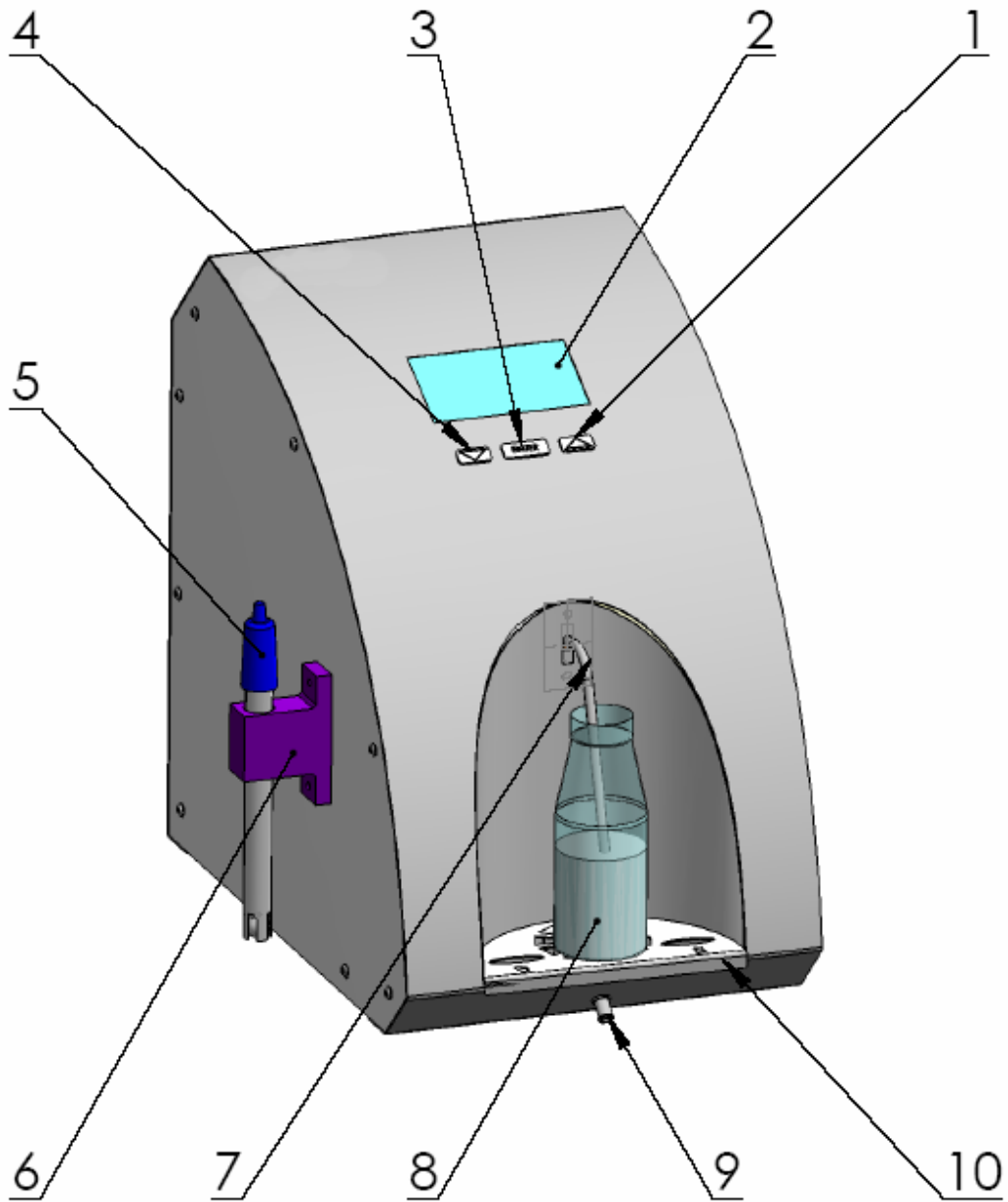

1. Button Up	6.pH probe holder
2. Display	7.input pipe
3. Button Enter	8. sample holder
4. Button Down	9.waste liquid pipe
5.pH probe	10. ss grid

Fig.2 Back panel

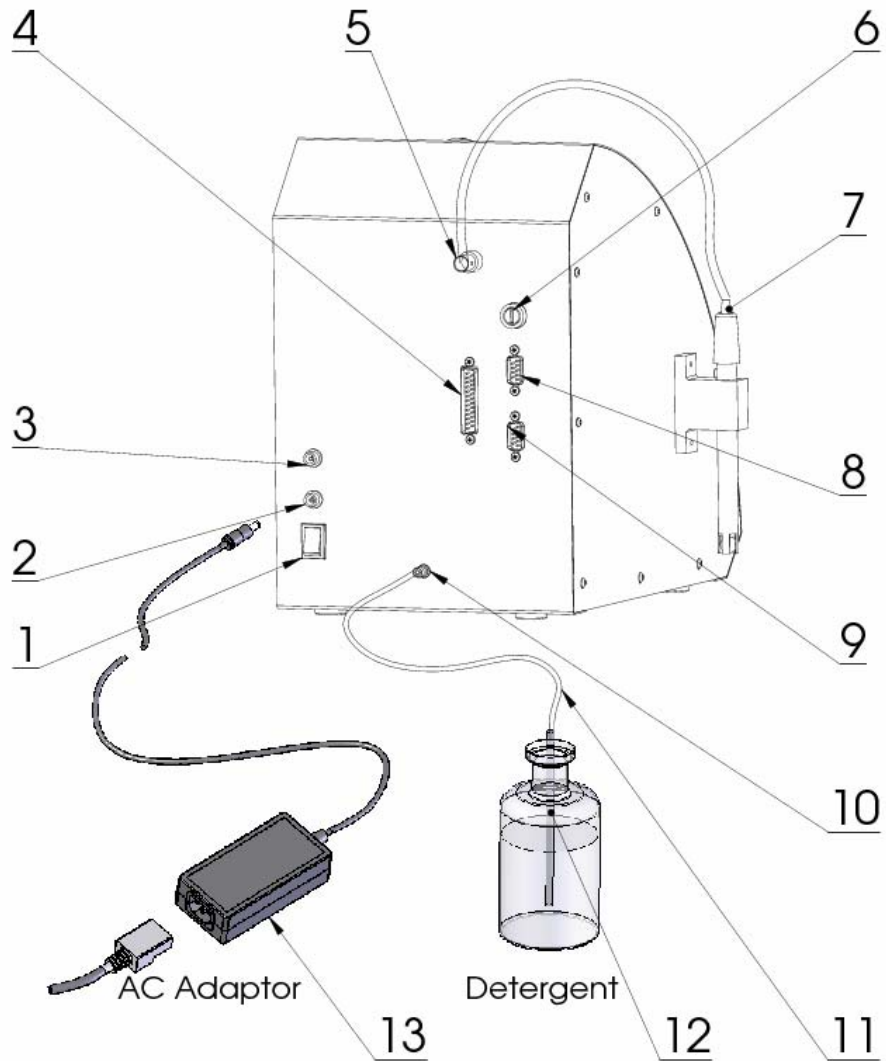

- | | |
|-------------------------------|---|
| 1. Power switch | 8. Com Port 2 |
| 2. AC adaptor input | 9. Com Port 1 |
| 3. DC Power Supply output | 10. Connector for the cleaning solution |
| 4. Parallel printer connector | 11. Plastic pipe |
| 5. pH probe input (option) | 12. Metal pipe |
| 6. Weigh Scale input (option) | 13. Switching adapter |
| 7. pH probe | |

Fig 3 Principle working scheme

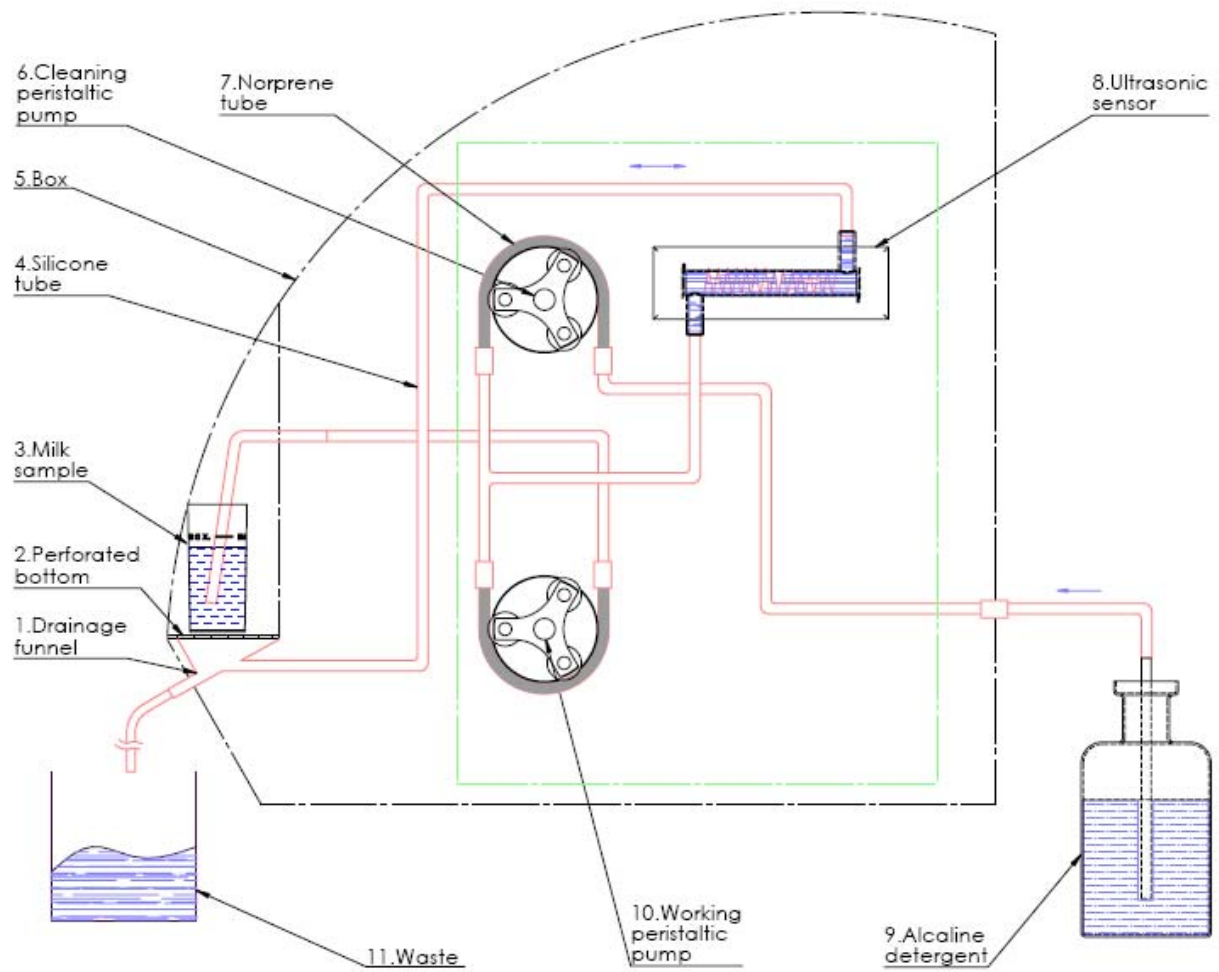

Fig. 4 Connecting peripheral devices

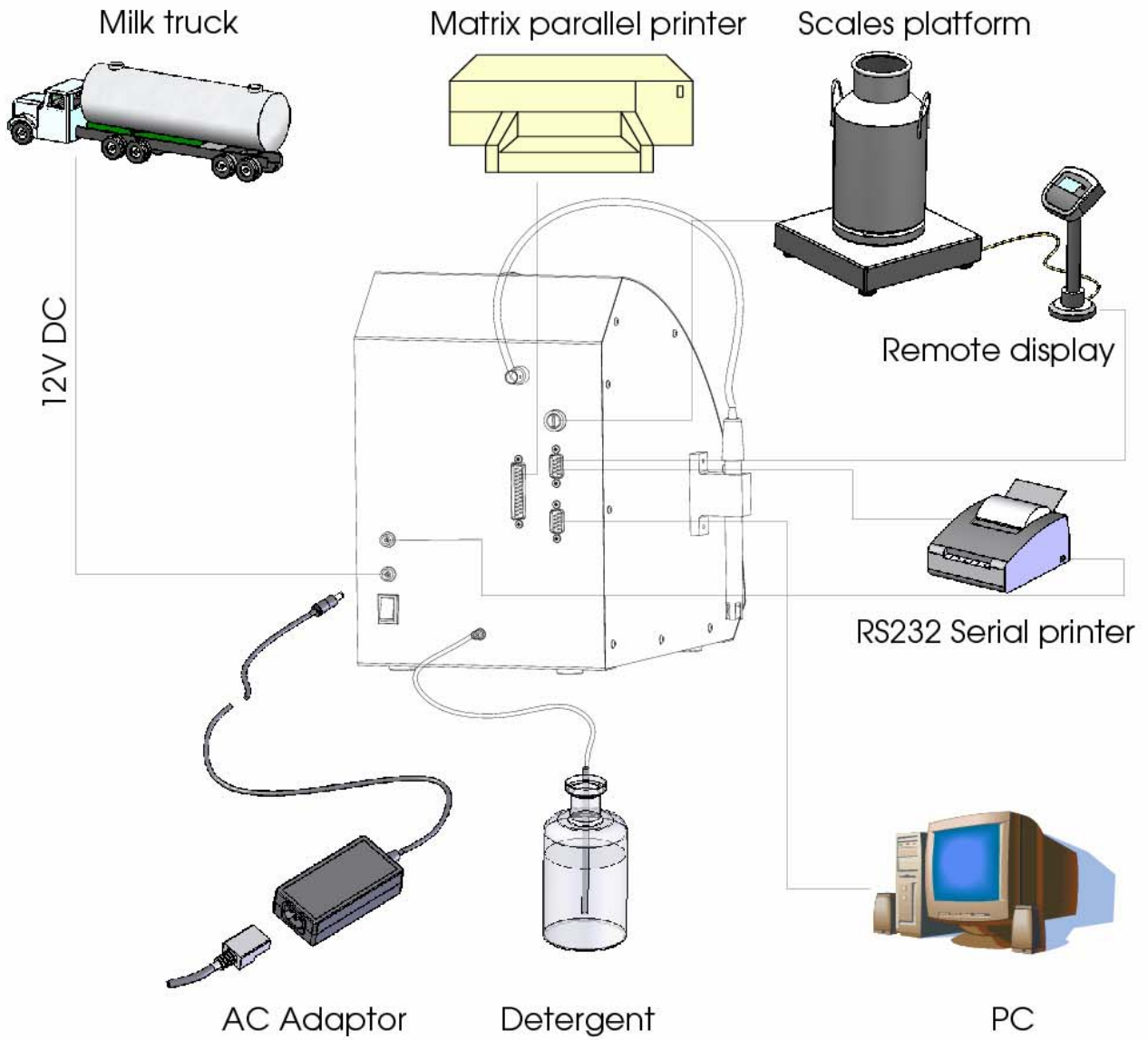
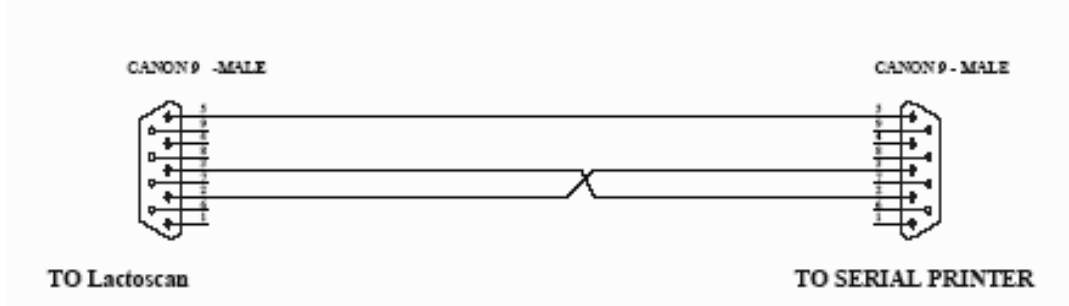

Fig. 5 Cable Description

Art. Number 30011

RS232 Interface Cable - Milk Analyser – Serial Printer



Art. Number 30012

RS232 Interface Cable - Milk Analyser – IBM PC

<p>2. TxD 3. RxD 5. GND</p>	<p>Milk Analyser DB 9-pin male</p>		<p>PC DB 9-pin female</p>	<p>2. Receive Data (RxD) 3. Transmit Data (TxD) 5. Signal Ground (GND)</p>
-------------------------------------	------------------------------------	--	---------------------------	--

Art. Number 10128

Probe pH with cable

Art. Number 30030

DC 12V Power Supply Milk Analyser Cable

- 1. GND
- 2. No connection
- 3. No connection
- 4. 12V DC

3. QUALIFICATION OF RAW MILK, THERMALLY TREATED MILK, OTHER DAIRY PRODUCTS AND DERIVATIVES

3.1. Taking samples and preparation for analyses

In order to receive reliable results in qualification of milk, dairy products and derivatives are needed: precise samples taking; correct samples storing (in need to be preserved); correct preparation before making measurement. The rules and requirements for this are described in details in *Appendix Milk sampling*.

3.2. Making the measurement.

3.2.1. Preparing the analyser for working mode

3.2.1.1. Put the analyser on the working place, providing good ventilation and not in the vicinity of heat providing devices or sources. The temperature in the premises has to be in the boundaries 10-40°C.

3.2.1.2. Check if the power switch is in "0" position and that the outlet voltage complies with the voltage indicated on the switching adapter of the analyser

3.2.1.3. Switch on the "POWER" button, which starts the identification procedure. For a short time the display shows the number of the software versions, for example:

Milk analyser xxx
LCD vers xx
MA vers yy
MA ser. N. xxxx

Where:

Milk analyser xxx	- is the time for measurement.
LCD vers XX	- is display control software version.
MA vers YY	- is the motherboard software version.
MA ser. N. xxxx	- is the serial number .



If in the process of exploitation there is a need to ask a question the company-producer, you have to send the data, written on the display during the above described initialization procedure.

3.2.1.4. Till the analyser is prepared for work (at about 5 minutes) the following message is written on the display: “**Getting ready**”. Above pointed time is in dependence of the environmental temperature and increases with decreasing the temperature.

3.2.1.5. When the device is ready for work, a beep is heard and the display shows: “**Ready to start**”. The analyser is ready to make analyses in mode 1 (normally Cow)

3.2.1.6. If you want to pass to another mode press the button **Enter** and hold it pressed. The following message appears on the display:

**Release button to
start menu**

Release the button **Enter**. The display shows the possible working modes:

Milk selector
Cal1 – Cow
Cal2 – Sheep
Cal3 – UHT

Cleaning
Final clean

Using “up” ▲ and “down” ▼ buttons choose the working mode and press **Enter** in order to start it.

3.2.2. Making analyses



Make sure the analyser is still during measurement. Vibrations may lead to inaccurate results.

To start measurement:

- pour the preliminary prepared sample in the sample holder (now you may use holders with different size - plastic and glass 100 ml);

Fig.6 Input pipe



The input pipe of the analyser is knee-joint (mobile). Move it forward in order to be possible to dip its end in the milk sample and place the sample holder in the recess of the analyser..

- press the button **Enter**.

The analyser sucks the milk, makes the measurement and used milk sample is poured through the holes of the grid below the input pipe of the analyser and enters the vessel for collecting waste liquids (see Fig. 3 Principle working scheme of the analyser). During the measurement the temperature of the sample is shown on the display.

Ignore the results received immediately after switching on the analyser and after measuring distilled water. Make a second measurement with new portion of the same sample.

3.2.3. Displaying the results

3.2.3.1. When the measurement is finished, the sample returns in the sample-holder and the display shows the results. For example:

Results:
F=ff.ff S=ss.ss
D=dd.dd P=pp.pp
L=ll.ll W=ww.ww

Where:

- F= ff.ff** - measured FAT in percentage;
- S= ss.ss** - measured SNF in percentage;
- D= dd.dd** - measured density in percentage;
- P= pp.pp** - measured protein in percentage;
- L= ll.ll** - measured lactose in percentage;
- W= ww.ww** - measured sample's added water in percentage;

By pressing the button "Down" ▼ the display shows the second page, containing the results:

Page 2 Results:
T=tt.tC pH=pp.pp
FP=-0.fff sol=0.sss

Where:

- tt.tC** - sample's temperature;
- pp.pp** - sample's pH result – if there is a pH probe connected;
- 0.fff** - measured sample's freezing point;
- 0.sss** - measured salts values;

By pressing the button "Up" ▲ display shows the third page with results:

Page 3 Results:
L=l.ll

Where:

- L= ll.ll** - measured Lactose in %;

By pressing the buttons "up" ▲ and "down" ▼, the operator has the possibility to pass from one page result to another.



If the device has an embedded option "Conductivity" and "conductivity measurement" started, the result is shown on the display, showing the basic results replacing lactose results in the following way:

C=xx.xx

In this case the Lactose result is shown on a new page - Page 3 Results. xx.xx is the measured milk sample's conductivity in [mS/cm]. If the results are outside the limits for this type of sample (see table from the Appendix

Conductivity measurement), the cursor flashes after the letter C, reminding that the sample is not correct. On the printout it is printed as !!!.

If the conductivity value is outside measuring range (2-14 mS/cm), the following message appears on the display:
C=OutRg (Out of Range), and on the printout there isn't any line with conductivity value.

3.2.3.2. Write down the results in the form. The results remain on the display till a new measurement is started. If the analyser is connected to a computer, it automatically sends the data to the computer and/or prints them.

4. CLEANING THE ANALYSER

This procedure prevents gathering milk fat residues and milk stone on the sensor. The milk stone consists of milk solids, calcium, iron, sulphates, magnesium, etc. All these substances form layer on the pipe and sensor's walls, which leads to deviations in the measurement results and blocking up the piping.



The company-producer recommends usage of the chemicals, supplied with the analyser – alkaline and acidic (Lactodaily and Lactoweekly). You may order them separately or together with the analyser. Try to use only these chemicals for cleaning the analyser.

In case you missed to order these chemicals the alternative is to use alkaline and acidic cleaning solutions for dairy, produced by one the companies, supplying such chemicals:

<http://www.johnsondiversey.com/Cultures/en-GB/OpCo/Your+Business/Dairies.htm>

http://www.ecolab.com/SolutionGuide3.asp?name=1345&PS_GRP_CD=FDBV&BUS_NM

http://www.calvatis.com/documents/products/produkte_farm_melkhygiene.pdf

4.1. Automatic cleaning the analyser

Analyser's contamination as a result of the irregular cleaning is the basic reason for inexactness during measurement. In order to be avoid this, in the milk analysers with peristaltic pump is embedded automatic cleaning. For this purpose the analyser has to be prepared on the following way:

The reservoir with the cleaning solution have to be connected towards the analyser and outgoing pipe towards reservoir for collecting the measured samples and used cleaning solution, as is shown on Fig.2.



Pay attention to the pipes in both reservoirs. The pipe in the reservoir with the cleaning solution has to be well dipped in the cleaning solution while the pipe in the reservoir with the already used samples and cleaning solution **MUST NOT** be dipped in the liquid.

Pay attention to the level of the cleaning solution in the reservoir. Add solution when the level is below 2/3!

Description of the cleaning procedures:

There are two ways of cleaning the analyser embedded in it – current and end (final) cleaning.

4.1.1. Current cleaning.

4.1.1.1. Automatic start

The current cleaning is made with alkaline solution (for working solution preparation see 4.2.1.), with which the reservoir for the cleaning solution is filled in.

It is automatically started, without operator's interference after the set time intervals elapse

- 1.** 55 min. after switching on the power supply of the analyser, but idle work;
- 2.** 15 min. after the last measurement of real milk sample.

After cleaning a new measurement is started in the above described intervals.

The display shows the following message and a sound signal is emitted:

**Auto clean
started!
Put empty glass**

After this the cleaning is started. The display shows:

**Cleaning
Please wait**

If there is a glass with sample it is completely emptied and then the analyser automatically fulfills procedure for sucking the cleaning solution and rinsing the analyser's inner system. In order the input metal pipe to be cleaned out for a short time a cleaning solution is pumped out for a short time in the already empty glass or in case there is no empty glass there – in the funnel for the waste liquids. It is filled to the middle and then is sucked back and poured in the reservoir with the used liquids. In case that you are sure that you'll not use the analyser for a longer period, but it will be connected to the power supply and switched on, which means that the process of automatic clean will be active, do not leave sample holder in the recess of the analyser, in order not to be overfilled during cleaning from the output pipe. Then the cleaning solution will be directly poured in the funnel for waste liquids.

After the cleaning is finished the displays shows the following:

End of cleaning

After 2 seconds the display shows:

Analyser ready

Then the analyser is ready for normal measurement.

4.1.1.2. Manual start

The current cleaning may be completed by manual start of the menu **Cleaning**. It is used before starting the menu Final Clean. It serves for cleaning the fats from the measuring tract with alkaline cleaning solution with which the canister is filled in. It is started using the menu for choosing the working mode of the analyser. After the measurement is completes, by continuous pressing the button **Enter**, the possible analyser operation modes are shown on the display.

**Cow
Sheep
UHT
Cleaning
Final Clean**

By choosing **Cleaning** the current cleaning is started. The display shows the following:

**Auto clean
started!
Put empty glass**

In this way the current cleaning is started. The procedure and operator's actions are described above.



Do not switch off the device at the end of the working day before the automatic cleaning procedure is completed. If it is not automatically cleaned and there is not a possibility to wait starting the automatic cleaning, then start manually the cleaning procedure with alkaline cleaning solution and if it is necessary with acidic cleaning solution as it is described below.

4.1.2. End (final) cleaning.

4.1.2.1. Final cleaning.

It is done with acidic cleaning detergent (for working solution preparation see 4.2.2.). It is done daily. Serves for cleaning the protein deposits from the measuring system of the analyser, which were not removed during work with the alkaline cleaning solution and removing milk stone layers.



Do not use chemicals, which are not intended for milking equipment and vessels in dairy industry. Pay particular attention to the acidic cleaning solution concentration. The higher concentration may damage the measuring sensor.

Always before the final acidic cleaning rinse the device with alkaline cleaning solution by manual starting if it was not already automatically cleaned. It is necessary to be done in order to remove the milk residues which could react with the acidic cleaning solution.



Do not forget to rinse with clean water!

It is started using the working modes menu. After the measurement is completed, by pressing and holding pressed the button **Enter**, the display shows the possible working modes of the analyser.

**Cow
Sheep
UHT
Cleaning
Final Clean**

1. Choose **Final Clean**. After choosing the final cleaning, the following message appears on the display:

**Put filled with
Water glass
and press Enter
to Continue**

2. Put a glass filled with water and press the button **Enter** in order to continue the procedure. Then the following message appears on the display:

**Cleaning
Please wait**



Do not miss to clean with water because the residues from the alkaline cleaning solution could react with the acidic solution, which will lead to gas and sediment formation.

After rinsing with water, the display shows the following:

**Put filled with
Detergent glass
and press Enter
to Continue**

3. Pour warm alkaline solution in the glass and press the button **Enter**, in order to continue the cleaning.

Then the following message appears on the display:

**Cleaning
Please wait**

Follow repeatedly sucking/pouring out the cleaning solution and heating it up. After the cleaning is finished, the cleaning solution is emitted in the reservoir with the waste liquids.



For maximum cleaning effect it is recommended the cleaning solution to be preliminary heated up to 40-50 degrees centigrade.

Follows rinsing with water:

4. Put a glass with water for rinsing the device.

**Put filled with
Water glass
and press Enter
to Continue**

After rinsing the display shows the following:

End of cleaning

After 2 seconds the following appears on the display:

Analyser ready

After this the analyser is ready for normal measurement or to be switched off from the power supply.

4.2. Preparation of cleaning solution

4.2.1. Preparation of alkaline cleaning solution

Preparation of 1 % alkaline solution of Lactodaily for circulation cleaning in the milk analyser:

1. Take the package 100 g concentrated powder chemical Lactodaily
2. Carefully cut the upper end, paying attention not to spill it.
3. In appropriate vessel (for example bucket) pour 1 l water.
4. Add the powder and then again water up to 10 l.

Then follow the instruction for milk analyser cleaning.

4.2.2. Preparation of acidic cleaning solution

Preparation of 1 % acidic solution of Lactoweekly for circulation cleaning in the milk analyser:



1. Take the package 100 g concentrated powder chemical Lactoweekly
2. Carefully cut the upper end, paying attention not to spill it.
3. In appropriate vessel (for example bucket) pour 1 l water.
4. Add the powder and then again water up to 10 l.

Then follow the instruction for milk analyser cleaning.



For final cleaning with the syringe it is recommended to use 1% acidic solution of Lactoweekly, preliminary heated up to 70 °C.

Fig. 7 Labels for acidic cleaning chemical Lactoweekly and alkaline cleaning chemical Lactodaily

L a c t o w e e k l y Acidic cleaner and descaler	L a c t o d a i l y Alkaline detergent sanitizer with QAC.
<p>General Description: Low foaming powder product for acidic cleaning of all types milk analysers Lactoscan according their instructions. The product very effectively removes milk stone and hard water deposits thus improving hygienic status of all milking equipment. May be used for manual application as well as for automatic circulation cleaning.</p> <p>Application: Automatic application: 1. Pre-rinse with sufficient water to remove milk residues 2. Circulate a 1% (10 g/l) cleaning solution for 10 to 20 minutes at a temperature above 40°C 3. Rinse thoroughly with tap water.</p> <p>Manual application: Use 0,5 - 1,0% (5 - 10g/l) after sufficient pre-rinsing at 30 to 40°C, soak for at least 10 minutes. Rinse thoroughly with tap water. Determination of concentration Titration of p-value with 1 N sodium hydroxide</p> <p>Special instructions: Keep container closed and away from humidity.</p> <p>Material compatibility: Stainless steel is not affected by the solution. Aluminum is slightly etched.</p> <p>Physical and chemical properties: Appearance: white powder Odour: faintly of surfactant pH-value (1%) 1,5 p-value: 4,5 Composition: Sulfamic acid, phosphates, sulfates, surfactant, defoamer Hazard label: Xi, irritant</p> <p>Risks: R 36/38 - Irritating to eyes and skin R 50/53 - Harmful to aquatic organisms, may cause long-term adverse effects in the aquatic environment For health and safety information, refer to the Safety Data Sheet (SDS) for this product</p> 	<p>General Description: Alkaline powder product with QAC for combined cleaning and disinfecting of all types milk analysers Lactoscan according their instructions. Suitable for all water conditions and may be used for manual application as well as for automatic circulation cleaning. Non corrosive on most materials and mild to skin.</p> <p>Application: Automatic application: 1. Pre-rinse with sufficient water to remove milk residues 2. Circulate a 1% (10 g/l) cleaning solution for 10 to 20 minutes at a temperature above 40°C 3. Rinse thoroughly with tap water.</p> <p>Manual application: Use 0,5 - 1,0% (5 - 10g/l) after sufficient pre-rinsing at 30 to 40°C, soak for at least 10 minutes. Rinse thoroughly with tap water. Determination of concentration Titration of p-value with 1 N Hydrochloric acid</p> <p>Special instructions: Keep container closed and away from humidity.</p> <p>Material Compatibility: Stainless steel and Aluminum are not affected by the solution.</p> <p>Physical and chemical properties: Appearance: white powder Odour: faintly of surfactant pH-value (1%) 11,5 p-value: 4,5 Composition: Carbonates, phosphates, silicates, surfactants, defoamer, disinfectant</p> <p>Hazard label: Xi, irritant</p> <p>Risks: R 36/38 - Irritating to eyes and skin For health and safety information, refer to the Safety Data Sheet (SDS) for this</p> 

4.3. Working with the peristaltic pumps

There are two peristaltic pumps in the analyser – 1 for the sample and 1 for the cleaning.

Fig.8 Peristaltic pumps

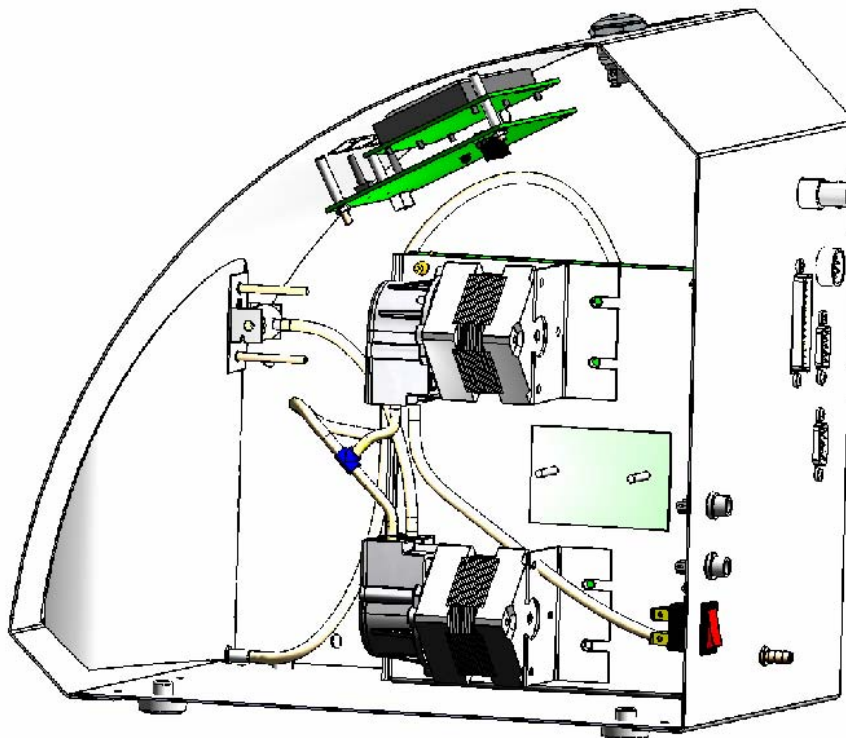
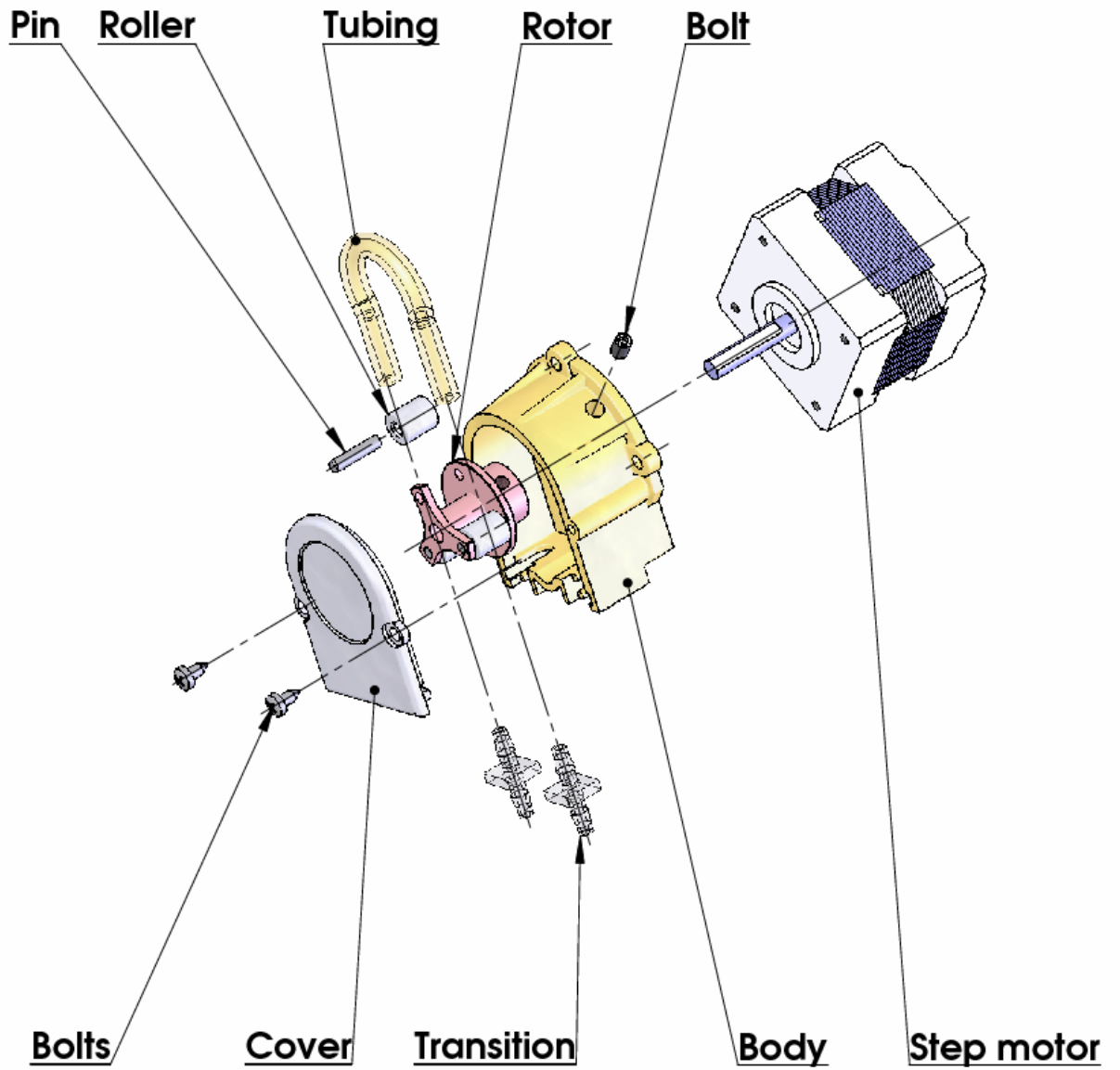

Fig. 9 Peristaltic pump SL 16



5. POSSIBLE MALFUNCTIONS AND ERROR MESSAGES, TROUBLESHOOTING

In the table below are described the possible malfunctions during the milk analyser's exploitation and ways for their repair/remedy. If the problem persists after all recommended measures are taken, please, connect the nearest service center.

Error message	Possible problem /cause	Repair/remedy
MA overheated Accompanied by a continuous sound signal	Overheated milk analyser	Immediately switch off the analyser. Pay attention the analyser to be situated away from direct sunlight or heating devices. Wait 5-10 minutes the device to cool down or to be normalized the ambient temperature and switch it on again.
Empty Camera	Insufficient quantity of the milk sample sucked in the system or air in the sample	The analyser is ready to measure the next sample. In order to avoid the future appearance of the same error message, please, check the following: <ul style="list-style-type: none"> - The sample is prepared according the instructions and there aren't air bubbles in it. - There is a real suction of the sample after starting measurement, i.e. it is obvious that the level of the milk sample in the sample holder decreases. In other case – there is damage in the suction system. - Avoid the end of the suction pipe to be above the surface of the liquid (not dipped enough). - Avoid curdling of the milk sample. Clean immediately if there is a sample curdled in the system. - In mode Measurement, after starting the measurement, remove the sample holder and see if there is no milk poured back in the sample holder.
Sample Overheat	Sucked overheated sample	The analyser is ready to measure the next sample. In order to avoid the future appearance of the same error message, please, check the following: <ul style="list-style-type: none"> -The sample is prepared according the instructions and its temperature does not exceed the maximum permissible sample's temperature. -Complete the procedure for checking the analyser in case of error message Empty Camera.

6. MAKING CORRECTIONS AND RECALLIBRATION OF THE DEVICE



At least once monthly check the correctness of the results and need of corrections and calibration.

In the process of work with the analyser there is a possibility the results to start differing between the data for some of the measuring parameters when measured with the milk analyser and the corresponding reference method of analyses (Gerber for fat, Kjeldhal for proteins etc). In order to establish the possible discrepancy and to correct the readings of the milk analyser do the following:

6.1. Taking samples and preparation of samples for checking the accuracy of the milk analyser, making corrections and recalibration

This is a basic moment for the correct checking the accuracy of the analyser and for making correct and precise correction and calibration. It is accomplished according *Appendix Taking and preparation of samples for checking correctness of the milk analyser, making corrections and recalibration.*

6.2. Determination the type of the discrepancy:

6.2.1. Making measurements

Make measurements with different samples (not less than 3) with known values of a separate parameter (for example fat content), determined by the known reference methods of analyses (for example Gerber's method for determination of fat content). For more accuracy it is recommended among these samples to be also such with values, close to the lowest and highest bounds for the measured parameters.

Make 5-time measurement for each of the samples. Calculate the average value for each sample parameter, without taking into consideration the first measurement for each sample.

6.2.2. Analyzing the measurement results

Make comparison between the values of the parameter from the reference sample and measured with the analyser. Make analyses of the difference received.

6.2.2.1. If the received differences are relatively constant value for samples with different content of the analyzed parameter, it is necessary to make correction.

For example

M% of the reference samples:	2,20	3,00	3,80	4,60	5,20
M% average when measuring with the analyser:	<u>2,38</u>	<u>3,17</u>	<u>4,01</u>	<u>4,79</u>	<u>5,42</u>
Difference:	0,18	0,17	0,21	0,19	0,22

Conclusion: the difference is relatively constant value and correction is possible to be done with – 0,2 % (see Corrections, p. 6.3.3)

6.2.2.2. If the differences are not a constant value it is necessary recalibration to be done.

For example.

M% of the reference samples:	2,20	3,00	3,80	4,60	5,20
M% when measured with the analyser:	<u>2,02</u>	<u>2,93</u>	<u>3,76</u>	<u>4,75</u>	<u>5,44</u>
Difference:	-0,18	-0,07	-0,04	0,15	0,24

Conclusion: It is obvious that the difference is variable value and recalibration has to be done (See Recalibration, p.6.4).

6.3. Making corrections

6.3.1. Possible corrections, limits and changing steps

Every parameter from each calibration may be separately corrected. Below is the table with possible corrections, limits and changing steps:

Parameter	Increasing	Decreasing	Step
FAT	0.95%	0.95%	0.01%
SNF	4.75%	4.75%	0.05%
Density	4.75%	4.75%	0.05%
Lactose	0.95%	0.95%	0.01%
Salts	0.95%	0.95%	0.01%
Proteins	0.95%	0.95%	0.01%
Added water	9.00%	9.00%	1.00%
Sample's temperature	9.90°C	9.90°C	0.1°C

6.3.2. Preparing the analyser for mode Corrections

6.3.2.1. Press the button **Enter** and without releasing it switch on the power supply of the device, wait for the starting identification messages and release the button after the following message appears on the display:

**Release button
to start setup**

After releasing the button on the display is shown:

MA Setup

followed by possible to be entered by the operator menus:

**Special modes
Corrections
Settings**

**Tests
pH & Co Meter
Accessories
Exit**

6.3.2.2. By using buttons “up” ▲ and “down” ▼ position on **Corrections** and press **Enter**.

6.3.3. Making correction

6.3.3.1 Determining the correction mode

When starting **Corrections**, the following appears on the display

**Corrections:
Calibration 1
Calibration 2
Calibration 3**

**Temperature
Exit**

By using buttons “up”▲ and”down”▼position on the corresponding calibration (for example **Correction 1 – cow**) and press **Enter**.

6.3.3.2. Choosing correction parameter

After choosing calibration mode the display shows the following:

Cal1 Correct's
FAT
SNF
Density

Lactose
Salts
Proteins
Water

Exit

Using the buttons “up”▲ and”down”▼position on the parameter to be corrected (for example **FAT**) and press the button **Enter**.

6.3.3.3. Making correction

After choosing parameter (for example fat) the display shows the following:

FAT Correction
0,05
 - **OK** +

Using the buttons “up”▲ and”down”▼is possible to increase or decrease the value of the measured parameter in the above pointed limits. Leaving this mode means saving the correction value and activating it.

6.3.3.4. Making verification

After the corrections are made put the milk analyser in working mode following the sequence below:

1. Switch off the power supply.
2. Switch on the “**POWER**” button, which starts the identification procedure. For a short time the display shows the number of the software versions, for example:

**Milk analyser xxx
LCD vers xx
MA vers yy
MA ser. N. xxxx**

3. Till the analyser is prepared for work (at about 5 minutes) the following message is written on the display: "**Getting ready**".
4. When the device is ready for work, a beep is heard and the display shows: "**Analyser ready**". The analyser is ready to make analyses in mode 1 (normally Cow).
5. make several times measurement of reference samples with known values of the corrected parameter. If the difference between the values of the parameter from the reference methods and milkanalyser are in the limits for the parameter it may be considered that the correction is successfully made.

If the discrepancy between the measurements from the milk analyser and classical methods is bigger than is necessary to make second correction according above described way.

If after the second correction the results are unsatisfactory we recommend making a calibration of the analyser. In dependence of the conditions and your requirements you may make the calibration using a personal computer type IBM PC and the company's calibration program or autonomous - by recalibration.



When making corrections or calibrations be 100% sure in the accuracy of the reference methods result.

6.4. Recalibrating the milk analyser

6.4.1. Running the analyser in mode Recalibrate

6.4.1.1. Press the button **Enter** and without releasing it switch on the power supply of the device, wait for the starting identification messages and release the button after the following message appears on the display:

**Release button
to start setup**

After releasing the button on the display is shown:



Followed by the possible to be entered by the operator menus:

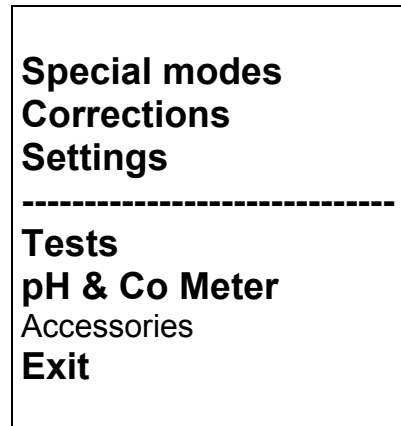

6.4.1.2. By using buttons “up” ▲ and “down” ▼ position on **Settings** and press button **Enter**.

6.4.1.3. Analogically, position on **Recalibrate** and press the button **Enter**.

6.4.2. Making recalibration

6.4.2.1. Determining the calibration mode

After starting **Recalibrate**, the display shows the following:

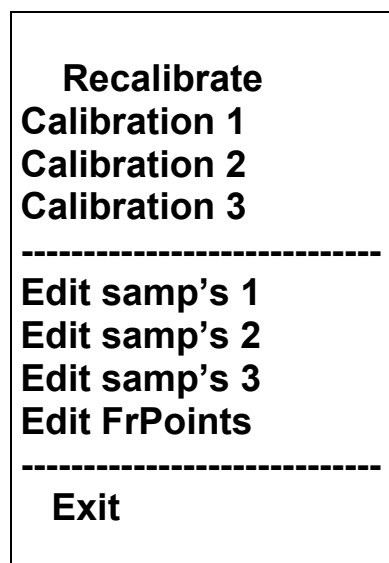

Using the buttons “up” ▲ and “down” ▼ position on the corresponding calibration (for example if you need to recalibrate cow milk, which is assigned in the milk analyser as **Calibration 1 - cow**) and press the button **Enter**. The following message appears on the display:

**Calibration 1
Getting ready**

6.4.2.2. Entering values for the separate sample parameters

Wait for the sound signal and the following menu on the display:

Cal1 Samp High
Fat=f.ff
SNF=y.yy
Den=d.dd

Lac=l.ll
Sol=s.ss
Pro=p.pp
Exit

In this display is possible to be entered the results from the milk **with high FAT** chemical analyses, which were received by the methods from Appendix Methods.

For example:

- by using the buttons “up” ▲ and ”down” ▼, choose the needed parameter to be entered;
- by pressing “**Enter**” the cursor will mark the number to be changed. For example: FAT=01.29;
- using the buttons “up” ▲ and ”down” ▼, enter the needed value;
- by next pressing of **Enter** pass towards the next number;
- after completion of entering the needed FAT value, press **Enter**;
- the cursor returns to its starting position.

Cal 1 Samp.High
Fat=f.ff
SNF=y.yy
Den=d.dd

With the button “down” ▼ move the cursor across SNF and analogical to the above described consequence enter the value for SNF and after that the rest of the values.

Using menus **Edit samp's 1(2, 3)** the operator has the possibility preliminary to prepare the data for the parameters for each recalibration separately or to check the sample data.

6.4.2.3. Making recalibration with the available samples

After entering the values for the separate parameters of the sample position the cursor across **Exit**, press **Enter** and the following menu appears on the display:

**Recalibrate 1
Put sample High 5
times**

Which reminds us to put 5 times the sample with high **FAT**.



The sample has to be with temperature in the boundaries 15-25°C.

Before each measurement:

1. Stir 2-3 times the milk sample before each measurement by pouring it from one vessel to another.
2. Pour the needed quantity in the sample-holder and put it in the recess of the device.
3. Start the measurement.
4. The sample is sucked.

Appears the following menu:

**Recallibrate 1
Put sample high 5
times
Samp T=16.8**

After the sample is measured, appears the following menu:

**Recalibrate 1
Put sample High
Cal meas=1/5**

Follow the procedure till the 5th measurement.
After 5th measurement completion automatically appears the menu:

**Cal 1 Samp Low
Fat = f.ff
SNF=y.yy
Den=d.dd**

**Lac=l.ll
Sol=s.ss
Pro=p.pp
Exit**

Which reminds to enter the values for the sample with low FAT? Enter the values analogically to the procedure, described in the previous sample. After entering the last parameter position the cursor on “**Exit**”, press “**Enter**” and the following menu will appear:

**Recal 1
Put sample Low 5
times**

Make 5 times measurement of the low FAT sample.
After 5th measurement completion automatically appears the menu:

**Recal 1
Put sample water**

Which reminds for 5-times water measurement? There is no need to enter values after placing the sample-holder. Measurement starts directly.



The used water has to be distilled or boiled.

After the 5th measurement appears the menu:

**Recalibrated
Analyser ready**

This means that the calibration was completed successfully and the analyser is recalibrated for cow milk, marked as “**Calibr 1**”.

Switch off the power supply of the device and switch it on again.

The device is ready to work with the new calibration.

If during work the sample's temperature exceeds the temperature range 15-25° C the following message appears:

**Temperature out of
range**

Wait till the end of the measurement. When the message appears:

Put sample again

Put sample with temperature in the temperature range and continue the measurement till completion of 5-time measurement.

7. STARTING THE DEVICE IN A SERVICE TEST/SETUP OPERATIONAL MODE. MENUS DESIGNATION

7.1. Starting the device in a service Test/Setup operational mode.

In order to start the **Setup** of the device the operator has to press the button **Enter** and without releasing it to switch on the power supply of the device, to wait for the starting identification messages and to release the button after the following message appears on the display:

**Release button
to start setup**

After releasing the button on the display is shown:

MA Setup

Followed by possible to be entered by the operator menus:

**Special modes
Corrections
Settings**

**Tests
pH & Co Meter
Accessories
Exit**

You may move in the menus by using buttons “**up**” ▲ and “**down**” ▼. If by pressing the button **Enter** you choose a menu, each menu offers new points/submenus. When **Exit** is chosen the device leaves the **Setup** mode and returns to normal work.



Due to continuous device improvement or due to the type of ordered type device it is possible some of the functions of the analyser to be not active (options not included). In this case, when trying to enter such function will display the following message: **Not available option**

7.2. Menus Function:

7.2.1. Special modes.

Serve for choosing special (technological) working modes. After starting it the following appears on the display:

```
Special modes
Calibration
Cycle
Exit
```

This mode is normally used in production conditions.

7.2.1.2. Calibration mode

In mode **Calibration** the analyser is ready to make measurement and to send the received results towards the technological milk analysers calibration system. For this purpose you need personal computer type IBM PC, company's calibration system LSC.EXE and methods for calibration of milk analysers (see the corresponding documents). To start measurement in this mode, the operator has to put a sample-holder containing milk sample in the recess of the analyser and to press the button **Enter**.

7.2.1.2. Cycle mode

Mode **Cycle** serves for training the analysers. When you start this mode, the analyser, without additional commands, sucks the sample, makes the measurement, pours the sample out in the sample-holder and displays the received results cyclically.

7.2.2. Corrections

Serves for entering corrections in the measured data. Detailed description in point 6.3.2 and 6.3.3.

7.2.3. Settings.

Serve for assigning different working parameters (modes).

7.2.3.1. Net number.

Serves for assigning the device network number when connecting it in the production network. The possible numbers are from 0 to 15 including. After starting this function the display shows the following:

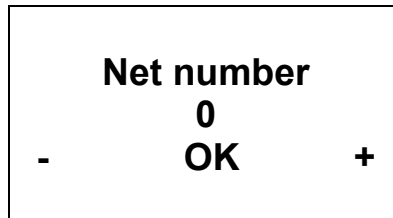

By using the button “up”▲ the operator has the possibility to increase the number, showing the channel’s number, and by button “down”▼, to decrease it. Pressing the button **Enter** saves the chosen channel and exits the function.



When connected in the production network each device has to have a unique number.

7.2.3.2. COM1 mode.

Serves for choosing the working mode of COM1 (RS232 on the rear panel). Chooses the device towards which the measurement results are send. There are two possibilities:

- towards a personal computer - PC;
- towards serial printer - Prn.

After starting this function the display shows the following:

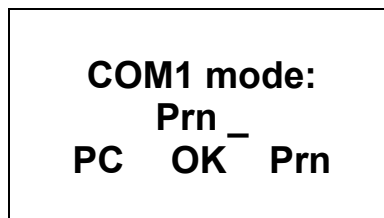

Using the button “up”▲” the operator has the possibility to send the results towards **Prn**, and by button “down”▼, towards **PC**. Pressing the button **Enter** saves the chosen output device and exits the function.

Forwarding the printer towards COM1 is necessary when connecting additional external keypad to the analyser. In this case the keypad is connected to connector Printer, and the printer – to connector RS 232.



Forwarding the printer could not be necessary if there is a special cable – fork-joint (from the company-producer), which allows both the keypad and serial printer to be connected towards connector **Printer**. In this case the connector **RS232** is free and may be used for communication with computer IBM PC type.

7.2.3.3. LCD Setup.

Serves to adjust the backlight of the display. The two parameters may be changed in two modes:

- fast – for rough adjustment;
- fine – for precise adjustment.

After starting this function the displays shows the following:

```
LCD Setup:  
B. Light fast  
B.Light fine  
Exit
```

7.2.3.4. Recalibrate.

Serves for changing definite calibration. Methods are described in point 6.4.

7.2.3.5. Edit FrPoint

Through this menu you have the possibility to enter the basic freezing point separately for each calibration. For more information, see *Appendix Freezing point*. After choosing the menu the following is displayed:

```
Edit FrPoints  
FrPoint Calibr1  
FrPoint Calibr2  
FrPoint Calibr3  
-----  
Exit
```

After choosing freezing point for the calibration, the following is displayed:

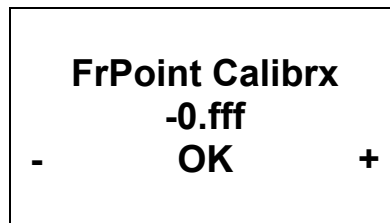

Where:

- Calibrx** - basic freezing point to be edited for chosen calibration;
- 0.fff** - basic freezing point current value;

By pressing the buttons:

- “up” ▲** - you may increase the absolute value of the freezing point;
- “down” ▼** - you may decrease the absolute value of the freezing point;
- “Enter”** - saves the edited value and exits the menu;

7.2.3.6. Save/Rest Cal.

Through this menu you may save the new calibration in the device or to restore the old one (factory) calibration. This is necessary in case that you’ve calibrated the device for cow milk, but after that the device is not measuring correctly and you decide to restore the factory calibration settings. Position the cursor across **“Restore calibration”** and press **“Enter”**

Possibilities:

Save calibration – saves the chosen calibration in an internal buffer.

Restore calibration – restores the chosen calibration from the internal buffer.

The procedure **Save/Restore** is done for each calibration separately.

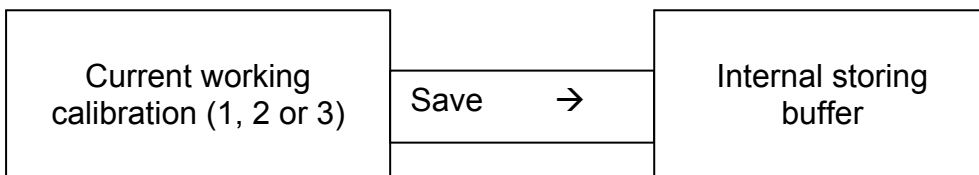

Current calibration content is not changed, the analyser continues using it, but there is a reserve copy in an internal buffer.

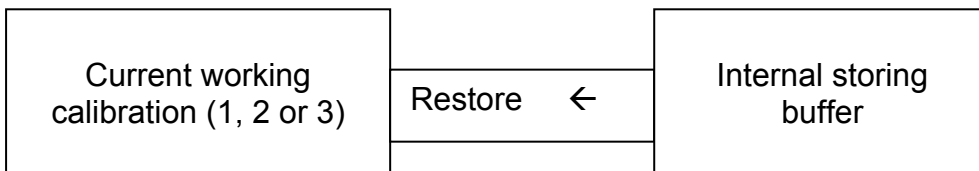

The current calibration is replaced with the calibration from the internal buffer and the analyser starts working with it. The content of the internal buffer is not changed.



If after recalibration “Save calibration” is pressed the new calibration settings will be saved over the factory settings. After that is impossible to restore the factory settings of the calibration. Save the newly made calibration only if you are sure about its correctness.

7.2.3.7. Settings Page 2.

After this menu is started the display shows the following:

**Settings Page2
Final clean Cnt
Auto Print Res
Larg Res En/Dis
Set Calibr Name
Exit**

Now there is a possibility one of the following options to be set:

7.2.3.7.1. Final Clean Cnt

Sets the number of cleaning cycles.

7.2.3.7.2. Auto Print Res.

It is possible (if it is needed) to prohibit the automatic printing the measurement results. If there is external keypad connected, then the results could be printed by pressing the button 1 from the keypad. It is possible to print out unlimited number of printouts for one and the same measurement.

7.2.3.7.3. Larg Res En/Dis.

The format of the measurement data send towards the computer is set.

If the option **Large Disable**, is chosen, then only the main results are send to the computer – Fat, SNF, Density, Lac, Proteins, Added Water, sample temperature, device serial number and calibration number.

If the option **Enable**, is chosen, except the above mentioned parameters also data for Salts, Freezing Point, pH, Conductivity will be send to the computer. In this case is necessary the software in the computer to be conformable to the format of the sent data. After starting the menu, the display shows (for example):

**Large Results
No**

No OK Yes

7.2.3.7.4. Set Calibr Name.

Sets the names of the separate calibrations. The name could be chosen from the group of predefined calibrations names or to edit a new one. When editing the new name there is a possibility all ASCII codes to be used, as letters (caps and normal), numbers and punctuation marks and popular symbols. The calibration name consists of 8 symbols.

Example:

When it is suitable to us this possibility of the analyser? For example if you have a device factory calibrated for Cow milk, Sheep Milk and UHT milk, but you need oftenly to measure camel milk. Using the methods, explained in details in Appendix Methods you may make a new calibration without need to send the analyser back to the producer for calibration. Using this procedure you may make calibrations for most oftenly analysed milk and to write down the exact calibration name, which will be shown on the display and printed on the printer.

After starting this menu the display shows:

Select Calibr
Cal1: Sheep

Exit Yes Next

There are the following possibilities:

With button **Exit** – to leave the menu.

With button **Yes** – to confirm the chosen for editing calibration name.

With button **Next** – to choose the next calibration name for editing.

If a calibration for change or edit of name is chosen, the display shows (example):

Cal:Sheep

PreDef Exit Edit

There are the following possibilities:

With button **PreDef** – to choose a calibration name from the list of preliminary given names.

With button **Exit** – to leave the menu.

With button **Edit** – to edit the new calibration name.

If a name from the preliminary given names list is chosen, the display shows:

**Cal1: Sheep
UHT
Exit Yes Next**

There are the following possibilities:

With button **Exit** – to leave the menu.

With button **Yes** – to confirm the chosen from the list calibration name. Now the program returns to the beginning of the menu for setting calibration names.

With button **Next** – to show the next calibration name from the list.

If it is decided a new calibration name to be edited, the display shows:

**Cal1: Sheep
User Edited
Name:
Prev Set Next**

There are the following possibilities:

With button **Prev** – to display the previous ASCII symbol.

With button **Set** – to confirm the ASCII symbol, shown on the display and passes to editing the next symbol from the calibration name.

With button **Next** – to show the next ASCII symbol.

After editing the last (eighth) name symbol, the display shows:

**Cal1: Sheep
User Edited
Name: MilkShp
Exit Save**

There are the following possibilities:

With button **Exit** – to leave the menu.

With button **Save** – to confirm already edited calibration name and to save it in the device. The program returns to the beginning of the menu for setting calibration names.

7.2.4. Tests.

Start different tests. Possibilities:

7.2.4.1. Test pump.

Starts pump's test. The number of the completed suction/display cycles is indicated.

7.2.4.2. Ultrasound.

Test for the ultrasonic system. Used in production conditions.

7.2.4.3. Serial Prn.

Display a short text of a serial printer, connected to COM2 – output with inscription **Printer** on the back panel of the device.

7.2.4.4. Set Amplitude.

Serves for ultrasound amplitude adjustment. It is used under production conditions or by the customer (after sensor change) according the instructions in the document *SetCell.pdf*.



Please, use this menu only after reading the above pointed document SetCell.pdf

7.2.5. pH meter & Co meter

Ph and conductivity measuring are additional possibilities for the analyser and are optional. Their usage is described in *Appendices PH Measurement and Conductivity Measurement*.

7.2.6. Exit

By pressing the button you may leave the program and pass towards another menu.

7.2.7. Summary of milk analyser setup functions

		Analyzer Setup	
Special modes	Calibration Cycle Reports Shut Down		
Corrections	Calibration 1	Fat SNF Density Lactose Salts Proteins Water	
		Calibration 2	Fat SNF Density Lactose Salts Proteins Water
			Calibration 3
	Temperature Cond measure		
		Settings	
			Recalibrate
	Calibration 1 Calibration 2 Calibration 3 Edit samp's 1 Edit samp's 2		

	Edit samp's 3	
Edit FrPoints	FrPoint Calibr1 FrPoint Calibr2 FrPoint Calibr3	
Save/Rest Cal	Save Calibr 1 Save Calibr 2 Save Calibr 3 Rest Calibr 1 Rest Calibr 2 Rest Calibr 3	
Fan Temp Offs Settings Page2	Final clean cnt Auto Print Res Larg Res En/Dis Set Calibr Name Option Select	
	Sel Pump Speed	Speed for Cal 1 Speed for Cal 2 Speed for Cal 3 HFSpeed for Cal OutSample Delay
	Reslt Precision	Fat - Precision SNF - Precision Den - Precision Lac - Precision Sol - Precision Pro - Precision AdW - Precision
	Properties	PCB Main Identi PCB LCD Identi

Tests

Test pump
Ultrasound
Serial Prntr
KeyPad
Displays
Parallel Prn

pH & Co
Meter

pH
Calibration
pH
Measuring
pH
En/Disable
pH U Display
pH Test U[V]
Co Meter
Calibr
Co Meter
Test
Co Meter
En/Dis

Accessories

Weight scale

Raw Test
Calibration
Measure
On Line En/Dis

Battery

Measure Bat U
Ctrl Enabl/Dis

RT Clock

Display Time
Adjust Time
Adjust Date

8. ADDITIONAL POSSIBILITIES OF THE ANALYSER

8.1. Connecting to 12 V DC power supply.

If there is a need the analyser to work on place without electrical supply available, then it could be powered by car battery or other 12 V DC external power supply. Use the 12 V power supply cable (art. number 30030).

8.2. Connecting to IBM PC

The analyser can be connected to IBM PC using the RS232 interface cable (art. number 30012, Parts and Accessories, point 16). In order to make the connection: switch off both the milk analyser and PC. Connect the RS 232 cable towards Com. Port 1 and towards the computer. Turn on both analyser and PC. Now the device is ready to communicate with IBM PC. For more detailed information regarding milk collection data program see the file resLS_SupLiters.pdf from the CD, accompanying the device.

8.3. Connecting additional serial printer (option).

The interface connector for the printer is on the rear panel of the device (Com. Port 2). The printer should be connected towards it. Connect it via cables, delivered by the company-producer. If the printer is connected directly to the electrical network, then the analyser and the printer should be connected to one and the same electrical phase.

Communication parameters: 9600 bps, No parity, 8 bits, 1 stop bit. It's one-way communication (uses one line) – the analyser only sends and the printer only accepts data.

8.4. Connecting matrix printer (option).

If the device is working in milk collection center, where work load is heavy, and there are a lot of results to be printed out, we suggest an option connecting standard matrix printer (paper expenses would be less, the reliability better).

Interface connection with the printer is at the rear panel of the analyser "Parallel printer interface".

8.5. Connecting and working with external keypad (option).

It is possible external keypad (supplied by the producer of the device) to be connected to the device, using special cable to the serial printer connector. In order to connect external keypad to the milk analyser, follow the procedure below:

1. Connect the keypad towards connector labeled Printer.
2. Connect the printer towards connector labeled **RS 232**.
3. Forward the printer towards output **RS 232**, doing the following:
 - Press the button **Enter** (on the front panel of the analyser).

- While holding it pressed, switch on the analyser's power supply.
- Release the button **Enter**.
- Using the buttons **Up/Down** choose menu **Settings** and press **Enter**.
- Using the buttons **Up/Down** choose menu **COM1 Mode** and press **Enter**.
- With the right button (**Up**) choose **COM1 Mode – Prn**, press **Enter** and leave the menu.

With the external keypad 4 digit identification number of the milk deliverer may be entered (from 1 to 9999) and quantity of delivered milk in liters (from 0,1 to 9999.9) (accurateness up to 0.1 l). These data entering have to be completed before starting measurement. Pressing the button **Enter** on the keypad will display the following:

Enter Data
Del N:

Now enter the deliverer's identification number. After pressing **Enter** on the external keypad, the display shows:

Enter Data
Del N:xxxx
Liters =

Now, enter how many liters have been delivered and press the button **Enter** on the external keypad the following is displayed:

Del N:xxxx
Liters=yyyy.y
Are you sure?
0-No Yes-Enter

Where:

- xxxx** - entered by the operator identification number of the deliverer
yyyy.y - entered by the operator liters.

The operator has two possibilities:

1. To cancel the entered data by pressing the button 0 on the external keypad and to start entering them again.
2. Confirm the entered data by pressing the button **Enter** on the external keypad. The display shows currently chosen calibration. The device is ready to start measurement. After completing the measurement, the data for the deliverer are printed out.

8.6. Measuring high fat samples (option).

The standard device measures samples up to 25% fat.

On customer's request, the device could be produced with possibility to measure samples up to 50% fat. The customer can choose which calibration to have this possibility and which not, as well as during the process of exploitation to change the measuring mode i.e. to pass from measuring normal fat percentage towards high and vice versa.

What the operator sees during these passes is the difference in the speed of sucking the sample. For that purpose, the high-fat sample has to be preliminary heated up to 30C +- 3C.

To choose the mode, follow the sequence below:

Setup->Settings->Settings
Page2->Option
Select->SelPumpSpeed->Speed for Cal x

After which the display shows:

<p style="text-align: center;">Calibr x Pump Speed</p> <p>Normal OK HiFat</p>
--

By pressing the correspondent buttons the operator can choose the type of measurement and to exit the menu.

When changing the type of measurement on a calibration is necessary a new calibration of the device on the new speed to be done. When calibrating measuring high fat sample, before starting the calibration procedure, the operator has to choose from the menu:

Setup->Settings->Settings
Page2->Option
Select->SelPumpSpeed-> HFSpeed for Cal

By which the device passes in a mode of measuring high fat samples. This calibration mode is active till the power supply of the device is switched off i.e. it has to be always set if the device will be calibrated for high fat measurement.

8.7. Working with embedded accumulator (option).

On customers' request accumulator could be embedded in the milk analyser. In this way it could work independently on the electrical network. In this case the Power switch on the rear panel of the analyser serves for close / open the electric circuit of the outer power supply. After closing the circuit, in order to start the analyser, the operator has to press the Start button on the front panel of the analyser.

Switching off the analyser could be done on one of the following ways:
 Through the analyser – by switching the Power button on the rear panel of the analyser.

Through the software – by using the option Shut Down from the Calibration and Working mode menus.

After pressing and holding pressed the button Enter (when choosing calibration), the following is displayed:

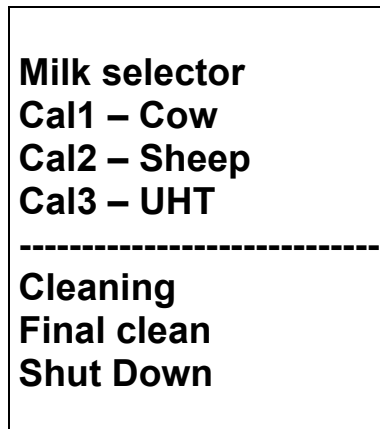

By choosing the option Shut Down the operator may switch off the power supply of the analysers.

In case that the external power supply from the electrical network, the analyzer automatically starts working with power supply from the battery. Possible working modes with battery:

1. The analyser is powered by the battery, works normally, the display shows the following message



2. The analyser is in mode Sleep – do not accept any commands, expects change in the power (supply from switching adapter for starting the battery), display shows the following

Low Battery

3. The battery power is under the allowed minimum, milk analyser is automatically switched off. Before switching off, for a short time, the display shows

Out of Battery

8.8. Embedded real time clock (option).

On customer's request, a real time clock could be embedded in the device, showing astronomical time and date. The clock is powered by battery, so it is independent on power supply of the device. The advantage of this option is that on the print out with the measurement results are shown also the exact time, when the measurement is made, for example:

```
Time: 18:14:33
Date: 22:03:2007
Lactoscan MCC30
Serial Number:0002
Calibr 1 Camel
Results:
Fat.....00.00%
SNF.....00.00%
Lactose.....00.00%
Solids.....00.00%
Protein.....00.00%
Temp. Sample...21.0°C
```

The embedded clock is controlled by the device's Setup, from the main menu Accessories, submenu RT Clock. When chosen, the display shows the following:

Display Time

Adjust Time
Adjust Date
Exit

Using these menus, the operator has the possibility to show on the display the current time and date, and if necessary – to adjust them.
The time is shown in the format:

hh:mm:ss
dd:mm:yy
Exit

where:

- hh - the current hour
- mm - current minutes
- ss - current seconds
- dd - current day
- mm - current month
- yy - current year

APPENDICES

APPENDIX 1 METHODS

1. Determination of milk's density

1.1. General

Milk density is defined as relation between the mass of definite milk volume at temperature 20 °C and the mass of equal volume distilled water at temperature 4 °C.

Density, alone, could not be used as a control parameter at milk quality control. Using the density the tentative figures for the SNF and salts could be determined.

1.2. Sampling and preparation for analyses

Sampling milk or other milk derivatives and their preparation for analyses is done according corresponding Appendices.

Milk density is determined not earlier than 2 h after milking. The milk must be with temperature from 10 to 25 °C.

Before determination of density the milk must be well stirred. To avoid foam formation, it has to be carefully poured on the cylinder's walls. The cylinder must be slightly tilted.

Before taking the readings the cylinder, with the milk must be placed on an even surface, facing the light, so the readings could be easily seen.

1.3. Basic principles.

The density of the milk is determined using aerometer, also called lacto-density-meter (milk density meter) and is expressed with a number, representing milk density meter degrees, decreased 1000 times or only with milk density meter degrees.

1.4. Necessary devices and reagents

- Aerometer /lacto-density-meter, milk meter/.
- Cylinder – with inner diameter not less than 5 cm, and length, corresponding to the dimensions of the lacto-density-meter.
- Ammonium with preliminary defined relative density.

1.5. Making the determination:

Dry and clean, the lacto-density-meter is slowly dipped in the milk till division 1,030, and then is left in free-floating state. The lacto-density-meter must not touch the cylinder's walls and to be on at least 5 mm from them.

When taking the readings the eyes must be on one and the same level with the meniscus. The reading is done in the meniscus' upper end with accuracy till 0,0005, and the temperature – with accuracy till 0,5 °C.



The difference between two parallel determinations must be not more than 0,0005.

1.6. Recalculating the values according lacto-density-meter at 20 oC.

If the milk, when determining its density, has temperature, higher or lower than 20 °C, the readings from lacto-density-meter are recalculated towards 20 °C.

Density recalculation towards 20 °C is done on the following way:
for every temperature degree over 20 °C from the received by the milkmeter value are added 0,2 ° for the cow and goat milk and 0,25 ° for sheep and buffalo milk lacto-density-meter degreed or 0,0002, respectively 0,00025 towards density; and for every temperature degree under 20 °C from the readings of milkmeter value are deducted 0,2-0,25 lacto-density-meter degrees or 0,0002, (0,00025) from the density.

2. Determination of fat content in the milk and milk derivatives.

2.1. General

For making analyses are used pure reagents for analyses (pure reagents for analyses (p.r.a.) and distilled water or water with equivalent purity.

2.2. Sampling

Milk and milk derivatives sampling is done according *Appendices Milk sampling and preparation of samples for analyses ad Sampling and preparation of samples for verification the accuracy of the milk analyser, making corrections and recalibration.*

2.3. Basic principles.

The method uses dissolving the milk and dairy products proteins with sulphuric acid with definite concentration in butyrometer and separating the fat under the influence of amilic alcohol, heating and centrifuging in a form of dense transparent layer, the volume of which is measured in the graduated part of the butyrometer.

2.4. Necessary devices and reagents

- Butyrometers for milk, special for skimmed milk and cream;
- Rubber stopples for butyrometers;
- Stand for butyrometers;
- Special pipettes or automatic for milk, sulphuric acid and изоамилов alcohol from 1, 10 and 11 cm³;
- Pipettes from 1 and 20 cm³;

- Glasses from 25 till 50 cm³;
- Centrifuge for Gerber;
- Water bath;
- Mercury thermometers up to 100 °C with value scale 1 °C;
- Sulphuric acid with density 1,82 at 20 °C for determination of fat content of the milk;
- Isoamyl alcohol for Gerber with density 0,811 to 0,812.

2.5. Making the determination:

Preparation of samples for analyses.

The milk is mixed well in order to become homogenous mixture (if necessary it is slowly heated up to 35-40 °C) and is carefully shaken and tempered to 20±2 °C. The samples from whey and buttermilk are preliminary filtered through double layer gauze and is then tempered to 20±2 °C. Cream samples are placed in water-bath at temperature 35 till 40 °C, stirred till homogenous sample is received and cooled down to 20±2 °C.

2.6. Making measurement

With butyrometer for milk

For milk, whey and buttermilk.

With automatic or special for acids pipette are measured 10 cm³ sulphuric acid with $d=1,820 \text{ kg/m}^3$ at 20 °C in the milk butyrometer. Carefully on the butyrometer's walls are piled up 11 cm³ from the prepared sample. The pipette is held till its full drainage.

For cream

From the prepared sample is measured 10 g with error up to 0,001 g and 50 cm³ water are added. Mixture is well stirred and heated up to 30-35 °C, then is again stirred and cooled down to 20±2°C, and the following steps are as with the milk sample using sulphuric acid with $d=1,789$ till $1,790 \text{ kg/m}^3$.

With butyrometer for cream

For cream

5 g from the sample are measured with butyrometer with error up to 0,0001 g and then 5 cm³ water are added, 10 cm³ sulphuric acid with $d=1,780$ to $1,790 \text{ kg/m}^3$ at 20 °C and 1 cm³ isoamyl alcohol. The butyrometer is closed with rubber staple and is shaken till the proteins are fully dissolved.

2.7. Calculating the results

By using milk butyrometer

Milk, whey, buttermilk.

Using the butyrometer's graded scale the grams fat in 100 g product are read directly. When the milk is curdled, the result is increased with 0,1 g for every degree.

By using cream butyrometer.

Cream

Using the butyrometer's graded scale the fat content in the products is directly read in percentages.

2.8. Measurement accuracy

By using milk butyrometer

The difference between two parallel determinations could not exceed:

For skimmed milk, whey and buttermilk - 0,05 g for 100 g product;

For cream - 0,5 g for 100 g product;

For milk - 0,1 g for 100 g product;

By using cream butyrometer

The difference between two parallel determinations could not exceed 0,5 g for 100 g cream.

3. Determination of water content and solids in the milk and milk derivatives.

3.1. General

The solids represent the fat content, proteins, carbohydrates and salts.

Sampling is done according *Appendices Milk sampling and preparation of samples for analyses ad Sampling and preparation of samples for verification the accuracy of the milk analyser, making corrections and recalibration.*

3.2. Basic principles.

Water content is determined by weight when drying at temperature (102 ± 2) °C of the weighted product till constant mass, expressed in grams for 100 g product.

The solids/dry substance is the mass of the dry remainder, received after dehydration of determined quantity product at temperature (102 ± 2) °C till constant mass and is expressed in grams for 100 grams of the product.

3.3. Necessary devices and reagents

- Assay balance with loading bounds 200 g and error 0,0002 g.
- Mercury thermometers from 0 to 100 °C and from 0 to 150 °C with value of scale division 1 °C;
- Pipettes from 5 to 10 cm³, class II;
- Glass banks with grind stopples with volume 100-200 cm³;
- Drying-oven with thermal regulator for keeping the temperature (102 ± 2) °C;
- Exicator with silicagel or another hygroscope material;
- Weight plates;
- Peg for the weight plates;
- Glass pods with rounded ends;
- Quartz, sea or river sands.

3.4. Making the determination:

Sample preparation for analyses.

The milk (whey, cream, and buttermilk) is well shaken. If needed, the sample is heated slowly up to 38-40°C, it is well mixed and cooled down to 20°C. Mixing and pouring are done at least three times in dry and clean vessel.

3.5. Making the measurement

The weight plate with 20-30 g washed out and tempered sand and glass rod is dried at 102±2 °C for 1 h, and then is taken out, covered with the cap, tempered with exicator (up to 30 min) and the mass is weighted with accuracy up to 0,0005 g. In the weight plate, using pipette, at about 10 cm³ milk are poured, covered and weighted. With the help of the glass rod milk is well mixed with the sand and without a cap is heated on a water-bath till a homogenous mass is formed. Then the weight plate is put in a drying-oven at temperature 102±2°C, it is dried out for 3 h, it is taken out of the oven, covered with the cap, tempered in exicator (up to 30 min) and the mass is weighted. Weight-glass is placed in the drying-oven again and is dried 1 h, then is taken out, tempered and weighted. This procedure is repeated till the difference between two consequent measurements becomes not more than 0,004g. In case that at the second or following drying procedure mass increases, then for the calculation is taken the previous measurement.

3.6. Calculating the results

Water content in grams for 100 g product (milk or milk derivatives), is calculated by the formula:

$$X = \frac{M_2 - M_3}{M_2 - M_1} * 100$$

Where

M1 - the mass of the plate with the sand and the glass rod, g;

M2 - the mass of the plate with the sand, the glass rod, and the sample before drying, g;

M3 - the mass of the plate with the sand, the glass rod, and the sample after drying, g;

The dry substance (Y) is calculated using the formula:

$$Y = 100 - X,$$

Where:

X is the calculated water content.

3.7. Measurement accuracy.

The difference between two consecutive measurements of one and the same sample could not be more than 0,2 g for 100 g product.

4. Determination of casein content in the milk.

4.1. General

The methods are based on the Volker's method. For making the analyses are used pure reagents for analyses (p.r.a.) and distilled water or water with equal purity.

4.2. Sampling

According corresponding *Appendices*.

4.3. Basic principles.

Added to the milk formalin liberates acidic residues from the protein's end groups, which are titrated with soda caustic solution. The soda caustic quantity is proportional to the casein in the milk content.

4.4. Necessary devices and reagents

- Glass 250 cm³.
- Pipettes Foll - 25,5 cm³.
- Pipettes Mor from 1 cm³, with division 0,1 cm³.
- Soda caustic p.r.a. - 0,143 n solution.
- Formalin 40% p.r.a - freshly neutralized.
- Phenolphthalein - 2 % solution in 70 % ethyl alcohol.
- Potassium oxalate p.r.a. 28 % water solution.
- Cobalt sulphate p.r.a. 5 % water solution.

4.5. Making the determination:

For cow milk

Reference sample preparation.

20 cm³ from the measured milk are poured in a glass vessel together with 1 cm³ 3 % water solution of cobalt sulphate. The sample is shaken and a slight rose color of the solution is received, which serves as a standard in the research.

4.6. Making the measurement

20 cm³ from the milk are measured in a glass and are titrated with 0,1 N soda caustic, using phenolphthalein as an indicator, till the color of the standard sample is reached. The volume of the used soda caustic is not taken into consideration.

4 cm³ 38-40 % formalin are added towards the neutralized sample and the rose color disappears as a result of the liberated carboxylic groups. It is well

stirred and titrated with 0,1 N soda caustic, till slight rose color is recovered. At the second titration the volume of the used soda caustic is measured.

For sheep milk

Casein content in sheep milk is determined on the same way. The only difference is that instead of 4 cm³ 38-40 % formalin in the milk are added 6 cm³, and the standard/reference sample is prepared with 1 cm³ 4 % solution of cobalt sulphate.

4.7. Calculations

The quantity of the 0,1 N soda caustic in cm³, used in the second titration, multiplied by the coefficient 0,7335 is equal to the casein content in the milk in percentages.

The following tables could be used for quicker readings of casein's percentage on the base of used cm³ 0,1 N soda caustic:

Table I

Calculation of casein content in the cow milk on the base of used cubic centimeters 0,1 N soda caustic:

0,1 n NaOH cm ³	Casein%	0,1 n NaOH cm ³	Casein %	0,1 n NaOH cm ³	Casein %
3,00	2,20	3,35	2,46	3,70	2,71
3,05	2,24	3,40	2,49	3,75	2,75
3,10	2,27	3,45	2,53	3,80	2,79
3,15	2,31	3,50	2,56	3,85	2,82
3,20	2,35	3,55	2,6	3,90	2,86
3,25	2,38	3,60	2,64	3,95	2,90
3,30	2,42	3,65	2,68	4,00	2,93

Table II

Calculation of casein content in the sheep milk on the base of used cubic centimeters 0,1 N soda caustic:

0,1 n NaOH cm ³	Casein%	0,1 n NaOH cm ³	Casein %	0,1 n NaOH cm ³	Casein %
5,40	3,96	6,10	4,47	6,80	4,99
5,45	4,00	6,15	4,51	6,85	5,02
5,50	4,03	6,20	4,55	6,90	5,06
5,55	4,07	6,25	4,58	6,96	5,10
5,60	4,10	6,30	4,62	7,00	5,13
5,65	4,14	6,35	4,66	7,05	5,17
5,70	4,18	6,40	4,69	7,10	5,21
5,75	4,22	6,45	4,73	7,15	5,24
5,80	4,25	6,50	4,77	7,20	5,28
5,85	4,29	6,55	4,80	7,25	5,32
5,90	4,33	6,60	4,84	7,30	5,35
5,95	4,36	6,65	4,88	7,35	5,39
6,00	4,40	6,70	4,91	7,40	5,43
6,05	4,44	6,75	4,95	7,45	5,46

4.8. Measurement accuracy.

Two parallel samples are measured and the difference between them could not exceed 0,1 %.

The accuracy of the method require the work to be done at place with good natural illumination, titration to be done evenly, without interruptions, colorless formalin to be used, preliminarily neutralized with soda caustic and phenolphthalein indicator.

Formalin titration is easy method, but it is not enough precise. More accurate results for casein content are obtained using Kjeldhal's method, but it requires special appliances.

5. Determination of salts in the milk

5.1. General

For the mineral substances in the milk conclusions can me made on the ashes content.

5.2. Sampling

According Appendices Milk sampling and preparation of samples for analyses ad Sampling and preparation of samples for verification the accuracy of the milk analyser, making corrections and recalibration.

5.3. Basic principles.

Milk is dried, carbonized and turned to ashes till constant mass. The ashes received are calculated in percentages.

5.4. Necessary devices and reagents

- Assay balance;
- Crucibles;
- Water-bath or infrared lamp;
- Hot plate or burner;
- Drying-oven with thermal regulator;
- Muffle furnace;
- Exicator;
- Quantity filter.

5.5. Making the determination:

In preliminary tempered and weighted crucible of the assay balance at about 10 g milk is weighted with accuracy up to 0,0005 g. The crucible with the sample is placed in a water-bath or infrared lamp till the evaporation of milk to dry state. Then it is carbonized with the burner or on a hot plate, paying attention not to be splashed out. The crucible is placed in a muffle oven and turns to ashes slowly, without the sample to be kindled, at temperature 500-550 °C till white or grey-white ashes. It is tempered in an exicator and is weighted till the appointed accuracy. Heating up in the oven is repeated till a constant mass is received.

5.6. Calculations

Ashes content is calculated using the formula

$$ashes = \frac{(C - A)}{(B - A)} * 100$$

Where:

A – the mass of empty, tempered crucible, g

B – the mass of the crucible together with the milk, g

C – the mass of the crucible with the received ashes, g

5.7. Measurement accuracy

The difference between tow parallel determinations could not be more than 0,02 %.

APPENDIX 2 REPRESENTATIVE SAMPLES FROM MILK AND OTHER MILK DERIVATIVES FOR MILK ANALYSER'S CALIBRATION

1. General

The samples used for analyser's calibration have to be representative for the corresponding milk type and have to be with known quality parameters: fat in percentage, SNF in percentage, density, lactose in percentage, total protein in percentage and salts in percentage. Changes in the analyzed parameters in the samples have, if possible, to cover the whole measuring range – i.e. used samples to be with low, middle and high content of the analyzed components.

The exact value of the parameters is decisive for correct and accurate calibration, because if the parameters are not set correctly during calibration the same parameter will not be measured correctly.

2. Necessary quality parameters values determination

For more precise determination of above listed quality parameters of the milk and its derivatives is advisable they to be examined in an authorized laboratories, using the corresponding arbitration methods for this purpose.

2.1. Laboratory methods

2.1.1. Determination of fat content

Determination of fat content in the milk and its derivatives (cream, whey, buttered milk) is one of the most important analyses in the dairy production and milk processing. According this parameter the payment schemes are made and it is observed from the point of view correct production process and the basic economy balances are made with its help.

A/ Röse-Gottlieb method

The fat content is determined using the gravimetric method, fat extraction from ammonia-alcohol milk solution using diethyl and petroleum ether, evaporation of the solvent and weighting the residuum.

B/ Gerber method

The proteins in the milk and dairy products are dissolved with sulphuric acid with definite concentration in butyrometer and the fat is separated under the influence of amyl alcohol, heating and centrifuging in a form of dense,

transparent layer. The volume of this layer is measured in the divided part of the butyrometer.

This is quick, easy method with sufficient accuracy. We recommend it for usage. For more detailed description see *Appendix Methods*.

2.1.2. Milk density determination

A/ With picnometer and Mor-Vestval scales

This is the most exact method for determination of milk and its derivatives' density.

B/ with aerometer (lacto-density-meter)

Compared with the above method this is quick and easy readable with satisfactory accuracy. We recommend it. For more detailed description see *Appendix Methods*.

During the lactation period and under the influence of different zoo engineering factors the density of the different milk kinds varies in the following bounds:

Milk kind	Minimum	Maximum	Average
Cow	1,027	1,033	1,030
Buffalo	1,026	1,032	1,029
Goat	1,027	1,033	1,030
Sheep	1,031	1,040	1,034

2.1.3. Determination of total proteins

A/ Kjeldahl method

Heating with concentrated sulphuric acid in the presence of catalyst mineralizes a definite volume of the milk sample. The liberated ammonium combines with the sulphuric acid and forms ammonium sulphate. After adding surplus soda caustic ammonium is liberated. When distilled it combines with the boronic acid. The quantity of the combined ammonium is determined by titration with acid with determined titer. From the combined with the ammonium acid the initial nitrogen content is determined, and also the proteins in the milk.

B/ Titration with formalin

Formalin, added to the milk, combines with the amino group in the protein's molecule and forms methyl groups, which have no alkaline reaction. Milk acidity increases by the liberated carboxylic groups, which are titrated with soda caustic solution. The used volume soda caustic is proportional to the protein content in the milk.

2.1.4. Determination of casein content in the milk

A/ Kjeldahl method

The total nitrogen content in the milk is determined. Casein is precipitated with acetic acid (acetate buffer) and is filtrated. The content of nitrogen in the filtrate is determined. Casein content is the difference between the two results for nitrogen using the Kjeldahl's method.

B/ Titration with formalin

More details for this method – see *Appendix Methods*.

2.1.5. Determination of salts in milk.

For the salts in milk and its derivatives is judged by its ashes content. Milk dries, becomes carbonized and turns to ashes till constant mass. The ashes received are calculated in percentage.

2.1.6. Determination of solids in milk

Solids describe the content of fats, proteins, carbohydrates and salts. Its value may be used for determination of each of these parameters in case of known other values.

Salts are determined by drying till constant mass – see *Appendix Methods*.

2.2. Express methods by using another milk analysers

It is possible another device to be used for determination of some of the quality parameters of milk and its derivatives samples, intended for calibration, but it has to be noted that it is possible incorrect values to be received, that's why it is necessary to be completely sure in the accuracy of their readings.

Usage of Milkoscan and other milk analysers based on the infrared measurement principle.

By using it the fat, lactose and protein content may be determined. Problem may arise with determination of salts and SNF. This is due to the impossibility of the infrared method to determine the solids and in order to receive the solids in the sample their meaning is accepted as a constant.

APPENDIX 3 MILK SAMPLING AND PREPARATION OF SAMPLES FOR ANALYSES

1. General

Milk sampling and qualification of raw, thermally treated milk and its derivatives (cream, whey, buttermilk etc.) is accomplished for every separate homogeneous batch. As homogeneous batch is accepted:

- Milk, delivered by a separate producer (an individual farm, farm etc.), and received from one kind of animals after their complete milking, independently from the number of milk-cans and tanks.
- Milk, received from one or several farms or milk collecting centers, but delivered in a joint vessel.
- In the enterprise – from one and the same kind raw milk poured in one vessel.
- For cream, whey, buttermilk etc. – produced as a result of milk processing and its derivatives from one and the same kind and quality, poured in a separate vessel.

Milk is qualified not earlier than 2 hours after milking.

When the milk is frozen it has to be warmed up to 10-15 °C and stirred according the below-described procedure.

A sample is taken from every separate vessel proportionally to the quantity of the milk in it. Samples from the different vessels are mixed well and from the received medial sample are taken 200 - 250 cm³ for accomplishing the needed analyses.

2. Stirring the milk and its derivatives before sampling

Milk stirring

It is a very important condition for receiving exact results. Before taking samples from big vessels the milk (fresh or thermally treated, whole-milk or whipped) has to be well stirred for no less than 5 min., by vertical and circular slow movements. Mixing spoon with long handle is used, allowing the lowest layers of the liquid to be reached.

The milk in the milk-cans is stirred 5 to 8 times from the surface to the bottom and reverse with slow circular movements.

Cream stirring

Due to the fact that the cream is significantly thicker liquid than the milk and contains high percentage fat it has to be preliminary very well stirred from the surface to the bottom with reciprocation movements at about 20-25 times.

Whey and buttermilk stirring

It is analogical to milk stirring.

3. Sampling

Samples from milk, whey or buttermilk are taken with metal or glass pipe (dry, clean and stainless-steel) with diameter at about 10 mm, which is slowly dipped till the bottom of the vessel and its upper end remains open. In this way it is filled with milk simultaneously with its dipping. When the pipe is taken out of the vessel its upper end has to be tightly closed with a thumb. For a bigger reliability of the analyses results it is recommended the quantity of the taken sample to be no less than 200 ml.

Cream sample is carefully well stirred in order not to form foam. For taking a medial sample from milk-cans and tanks a sample pipe is used. Stuck to its outer surface cream has to be removed by using filter paper, napkin or clean cloth, preventing in this way the proportionality between the samples and the total amount of the cream to be disturbed.

4. Sample preservation

The vessels where the samples will be put have to be clean, dry, glass, metal or from other suitable material, to be tightly closed with rubber or other stopples. The stopples not to absorb water and fat and not to influence the analyses sample content.

In summer the sample fills up to the top the vessel, but in winter – at least 3/4 from the vessel's volume. Each sample for analyses has to be labeled and described in a way not allowing to be mixed up.

The samples are stored in conditions, assuring temperature, corresponding to the requirements for storing such kind of product (advisable – 1 °C).

If there is a need of longer sample storing they have to be preserved; the most commonly used preservative is potassium dichromate ($K_2Cr_2O_7$) - 1 g for 1 000 ml. The samples have to be stored in a cold and dark place after the preservation. Have in mind that during the analyses the results for SNF% will be increased with 0,1 %. After adding the preservative the sample has to be well stirred.



Do not make analyses if the acidity of the milk is more than 25°T for cow and 28 °T for sheep milk.

5. Preparing the samples for analyses

Milk – raw and thermally treated

When examining samples taken immediately before analyses and shortly stored, the milk is poured several times from vessel to vessel in order to distribute the fat content uniformly. To avoid foam formation or separation of milk fat, the samples have to be carefully poured using the walls of the vessels, as they are tilted slightly. For a better mixing the sample it has to be poured at least 3 times. When needed the same is tempered to the temperature within the measuring range.

If there is fat stuck on the walls of the vessel and the stopple (when the samples were stored for a long time), the milk has to be slowly heated up to 35-40 °C. At the same time it has to be slowly shaken. The cream, stuck to the walls of the vessel is removed. The sample is poured several times and is cooled down (advisable up to 20 °C).



If there is separated liquefied fat or white particles with irregular form on the vessel's walls reliable results could not be received.

Whey

Before making analyses the whey sample is filtered through double sheet gauze put over the glass funnel in order to separate the fat grains get into liquid by incidence and if it is needed the sample is tempered and carefully stirred.

Buttermilk

Before making analyses the buttermilk sample is filtered through single sheet gauze put over the glass funnel in order to separate the big protein particles and if it is needed the sample is tempered and carefully stirred.

Cream

The sample is slowly warm up to 35 – 40 °C in water bath. The fat is dispersed wholly by carefully shaking and if necessary, by stirring with glass stick. The sample is poured from vessel to vessel several times and is cooled down (advisable to 20 °C). If after this procedure the sample is not homogenous, the measurement is not carried out.

Sample for analyses is prepared from homogenized cream by diluting it with distilled water in degree, sufficient for the components of the diluted cream to be reached in the measuring range of the analyser.

APPENDIX 4 SAMPLING AND PREPARATION OF SAMPLES FOR VERIFICATION THE ACCURACY OF THE MILK ANALYSER, MAKING CORRECTIONS AND RECALIBRATION.

1. Necessary consumables and devices

- Distilled water;
- Minimum 3 milk samples with known content of fat, SNF, protein, density, lactose, solids;
- Heating water bath;
- Cooling water bath or chamber;

2. General

Milk sampling and storage of samples of raw, thermally treated milk and its derivatives (cream, whey, butter-milk etc.) aiming verification the accuracy of the analyser, making corrections and recalibration is accomplished following the recommendations below:

- Sample to be taken from homogeneous batches, observing all the requirement;
- The sample's volume to be enough for making minimum 5 measurements for each sample or not less than 0.5 l;
- The samples to correspond to the standard physic-chemical and microbiological requirements, to be pure, without admixtures, without added cleaning or other unusual substances and without falsifications;
- Do not use samples with total acidity of milk more than 17°T;
- Vessels, where the samples will be handled have to be clean, dry, glass, metal or other suitable material, to be tightly closed with rubber or other stopples. The stopples not to absorb water and fat and not to influence the analyzed sample content;
- Till the start of the analyses the samples are stored in conditions, assuring preservation of their content and quantities (advisable low temperature – 1-3 °C).

For longer storage of the samples a preservative is added as was already described in p.9.1.1, and then the sample has to be well stirred.

3. Representative Samples

The samples have to be representative for the corresponding milk type. Changes in the analyzed parameters in the samples have, if possible, to cover the whole measuring range – i.e. used samples to be with low, middle and high content of the analyzed components.

Exemplary recommended values:

Cow milk

Parameter	Low value	High value
% fat content	2,00	6,00
% Solids-Non-Fat content	8,00	9,00

The Lactose percentage content (4,0-5,5; average-4, 7), Protein (2,00-4,00; average-3, 3), salts (0,7-0,8) is proportional to the SNF content. When preparing samples these values vary within limited bounds.

Sheep milk

Parameter	Low value	High value
% fat content	5,50	10,00
% Solids-Non-Fat content	9,00	11,50

The Lactose percentage content (average - 4,6), Protein (average - 5,8), salts (average - 1,0) is proportional to the SNF content. When preparing samples these values vary within limited bounds.

Buffalo milk

Parameter	Low value	High value
% fat content	5,50	10,50
% Solids-Non-Fat content	9,00	11,00

The Lactose percentage content (average - 4,7), Protein (average - 4,3), salts (average - 0,8) is proportional to the SNF content. When preparing samples these values vary within limited bounds.

Goat milk

Parameter	Low value	High value
% fat content	2,00	6,00
% Solids-Non-Fat content	8,00	9,00

The Lactose percentage content (average - 4,6), Protein (average - 3,7), salts (average - 0,8) is proportional to the SNF content. When preparing samples these values vary within limited bounds.

Cream

Parameter	Low value	High value
% fat content	8,00	20,00
% Solids-Non-Fat content	2,50	5,00

The cream samples are diluted with distilled water. Degree of dilution is 2-3 times, in dependence of the initial fat content in the cream.

Whey

Parameter	Low value	High value
% fat content	0,20	0,80
% Solids-Non-Fat content	5,00	7,50

The content of fat and SNF in the whey depends on the kind of the dairy product as a result of which the whey is received.

4. Samples preparation

Milk – raw or thermally treated

For raw milk sample with average content of the analyzed components is advisable to be used milk, collected from at least 10 animals from the most commonly met breed in the region where the analyser will be functioning.

Low fat and high fat samples are prepared on the following way:

Available fresh or thermally treated milk is poured in a separating funnel, which is place in a refrigerator for at least 12 hours at temperature 4 - 6 °C in order to stratify. For a bigger stratification a longer time is required.

The layer at the bottom is poured in a vessel. It is well mixed by pouring it from vessel to vessel and is warmed up to 40 °C in a water bath.

The upper layer is poured in another vessel.

Using the certified methods the density and the concentration of the analyzed components - fat, protein, SNF, lactose, salts are determined.



The analyser's accuracy depends only on the correctness of the chemical analyses of the components in the samples and the normal acidity during calibration!

It is recommended the first cow milk sample with low fat content to be with the following parameters:

1.8-2% FAT; 8.7-9% SNF; 3,3-3,5 % Protein; 4,8-4,9% Lactose; 0,75 Salts; 1030-1033 kg/m³ Density.

The second cow milk sample with high fat content to be with the following parameters:

5-5,5% FAT; 8.4-8,79% SNF; 3,1-3,2% Protein; 4,6-4,7% Lactose; 0,7 Salts; 1028-1029 kg/m³ Density.

Samples with medial values of the separate parameters are received by mixing the two boundary values in a definite proportion.

Preserve the samples, using above described method for their longer storage.

When using samples, stored shortly, preliminary pour the sample from one vessel to another in order to distribute the milk components evenly paying attention not to form foam in the sample.

When the samples are stored for a longer period it is recommended to warm it up to 35-45 °C, and the vessel to be shaken carefully. In case that there is a cream stuck on the vessel's surfaces – remove it. The sample is poured from vessel to vessel several times and is cooled down (advisable to 20 °C /.



If there is separated liquefied fat or white particles with irregular form on the vessel's walls this sample could not be used.

Whey and buttermilk

The samples are poured several times from vessel to vessel and if needed gradual heating with stirring with cooling down is done.

Cream

The sample is slowly warmed up to 35 – 40 °C in water bath. The fat is dispersed wholly by carefully shaking and if necessary, by stirring and pouring it from vessel to vessel till its full homogenization.

From homogenized cream is prepared sample for analyses by diluting it with distilled water in degree, sufficient for the components of the diluted cream to be reached in the measuring range of the analyser.

5. Advisable scheme for independently determination the content of different parameters in milk and its derivatives

When is not possible to use the help of authorized laboratories and above mentioned milk analysers we recommend you to follow the scheme:

5.1. For cow milk (whole milk, low fat, skimmed milk) and UHT milk

Determination of fat content – Gerber’s method, described in *Appendix Methods*.

Density determination – using aerometer, described in *Appendix Methods*.

SNF determination – by formula – p. 3.2.3.1.B

Determination of Lactose content – by formula – p.3.2.3.2.A

Determination of salts content – by formula – p. 3.2.3.3.A

Total protein content determination – by formula – p. 3.2.3.4.A

Example: Determination of the quality parameters for two samples cow milk (low fat and high fat), obtained and prepared according p. 2.3.1 and 2.4.1.

First – determine the fat content in the samples, using the Gerber’s method (p.3.2.)

Suppose that for the first sample the result is 2,0 %F, for the second – 5,9 %F.

Second – determine the milk density, using aerometer (p.3.1.)

Suppose that the results are 1,0316 for the first sample and 1,0274 for the second

Third – Calculate the SNF content using the formula (p.3.2.3.1.B)

$$SNF = \frac{0,075 * 2,0 + 100 - 100 / 1,0316}{0,378} = 8,50\%$$

$$SNF = \frac{0,075 * 5,9 + 100 - 100 / 1,0274}{0,378} = 8,23\%$$

Fourth – determine the lactose content by the formula (p.3.2.3.2.A)

$$Lact. = SNF * 0,55 = 8.50 * 0.55 = 4.67 \%$$

$$Lact. = SNF * 0,55 = 8.23 * 0.55 = 4.53 \%$$

Fifth – determine the salts content by formula (p.3.2.3.3.A /

$$Salts = SNF * 0,083 = 8.50 * 0.083 = 0.71 \%$$

$$Salts = SNF * 0,083 = 8.23 * 0.083 = 0.68 \%$$

Sixth – determine the total protein content by formula (p.3.2.3.4.A)

$$Proteins = SNF * 0,367 = 8.50 * 0.367 = 3.12 \%$$

$$Proteins = SNF * 0,367 = 8.23 * 0.367 = 3.02 \%$$

So, when calibrating the milk analyser we’ll use samples with the following parameters:

	<u>I st sample</u> (low fat)	<u>II nd sample</u> (high fat)

milk fat	2,00	5,90
SNF	8,50	8,23
density	1,0316	1,0274
lactose	4,67	4,53
salts	0,71	0,68
proteins	3,12	3,02

5.2. For sheep milk

Determination of fat content – Gerber’s method, described in Methods p. 3.4.

Density determination – using aerometer, described in Methods p. 3.3.

SNF determination – by formula – p. 3.2.3.1.B

Determination of Lactose content – by formula – p. 3.2.3.2.A

Determination of solids/salts content – by formula – p. 3.2.3.3.A

Total protein content determination – by formula – p. 3.2.3.4.A

Example: Determination of the quality parameters for two samples sheep milk (low fat and high fat), obtained and prepared according p. 2.3.1 and 2.4.1.

First – determine the fat content in the samples, using the Gerber’s method (p.3.2.)

Suppose that for the first sample the result is 5,6 %M, for the second – 9,8 %M.

Second – determine the milk density, using aerometer (p.3.1.)

Suppose that the results are 1,0352 for the first sample and 1,0300 for the second

Third – Calculate the SNF content using the formula (p.3.2.3.1.B)

$$SNF = \frac{0,075 * 5,6 + 100 - 100 / 1,0352}{0,378} = 10,11\%$$

$$SNF = \frac{0,075 * 9,8 + 100 - 100 / 1,0300}{0,378} = 9,65\%$$

Fourth – determine the lactose content by the formula (p.3.2.3.2.A)

Lact. = SNF * 0,45 = 10.11 * 0.45 = 4.55 %

Lact. = SNF * 0,45 = 9.65 * 0.45 = 4.34 %

Fifth – determine the solids content by formula (p.3.2.3.3.A /

Solids = SNF * 0,075 = 10.11 * 0.075 = 0.76 %

Solids. = SNF * 0,075 = 9.65 * 0.075 = 0.72 %

Sixth – determine the total protein content by formula (p.3.2.3.4.A)

Proteins = SNF * 0,475 = 10.11 * 0.475 = 4.80 %

Proteins = SNF * 0,475 = 9.65 * 0.475 = 4.58 %

So, when calibrating the milk analyser we'll use samples with the following parameters:

	<u>I 1st sample</u> (low fat)	<u>II nd sample</u> (high fat)
milk fat	5,60	9,80
SNF	10,11	9,65
density	1,0352	1,0300
lactose	4,55	4,34
salts	0,76	0,72
proteins	4,80	4,58

5.3. For wheat, buttermilk and cream

Determination of fat content – Gerber's method, described in Methods p. 3.4.

Density determination – using aerometer, described in Methods p. 3.3.

SNF determination – using drying - p. 3.3. and formula – p. 3.2.3.1.A

APPENDIX 5: EASY CALIBRATION OF THE MILK ANALYSER BY CALCULATING THE BASIC PARAMETERS VIA FORMULAS



DETERMINATION OF THE BASIC PARAMETERS IN THE MILK SAMPLE BY USING FORMULAS IS NOT AS PRECISE AS USING THE ARBITRARY METHODS, BUT IS SUITABLE FOR USAGE IN FIELD WORK.

5.1. Determination some of the parameters by formulas

There is dependence between the different parameters in milk and its density, which may be expressed with mathematical equation. On this base different formula, tested and confirmed by the classical laboratory methods for analyses, are developed. We recommend the following:

5.2. SNF determination.

For determination of SNF the correlation dependence exists between the milk's density, fat and SNF in the milk. When the density and the fat are known, the SNF can be calculated.

There are several formulas with different applicability.

A/ When the salts and fat are known

SNF is calculated by subtracting the fat percentage from the salts.

$$SNF = \text{Salts} - F (\%)$$

Where

Salts – salts in (%) ,

F – fat content in (%) ,

This formula is used for determination of SNF in whey, buttermilk, and cream.

B/ Known quantity of fat and density (most commonly used method when maximum accuracy is needed).

We recommend the following formula:

$$SNF = \frac{0,075 * F\% + 100 - 100 / \text{density}}{0,378}$$

This is a universal formula and actual for milk of almost all kind of cows and sheep all over the world.

5.3. Determination of lactose content

We recommend the following formulas:

A/ for cow milk

$$\text{Lact.} = \text{SNF} * 0,55 (\%)$$

Where

SNF – content of SNF in percentages (%),

0,55 – constant coefficient.

B/ for sheep milk

$$\text{Lact.} = \text{SNF} * 0,45 (\%)$$

Where

SNF – solids-non-fat content in percentages (%),

0,45 – constant coefficient.



This is an actual coefficient for sheep breeds on the territory of the Balkan Peninsula.

5.4. Determination of salts content

We recommend using the following formulas:

A/ for cow milk

$$\text{Salts} = \text{SNF} * 0,083 (\%)$$

Where

SNF – solids-non-fat content in percentages (%),

0,083 – constant coefficient.

B/ for sheep milk

$$\text{Salts} = \text{SNF} * 0,075 (\%)$$

Where

SNF – solids-non-fat content in percentages (%),

0,075 – constant coefficient.



This is an actual coefficient for sheep breeds on the territory of the Balkan Peninsula.

5.5. Determination of total proteins content

We recommend using the following formulas:

A/ for cow milk

$$\text{Protein} = \text{SNF} * 0,367 (\%)$$

Where

SNF – solids-non-fat content in percentages (%),

0,367 – constant coefficient.

B/ for sheep milk

$$\text{Protein} = \text{SNF} * 0,475 (\%)$$

Where

SNF – solids-non-fat content in percentages (%),

0,475 - constant coefficient.



This is an actual coefficient for sheep breeds on the territory of the Balkan Peninsula.

APPENDIX 6 FREEZING POINT DETERMINATION

1. Methods for determination.

The milk analyser determines the freezing point of each sample and the quantity of added water. The milk analyser does not measure the freezing point, but calculates it from the components it depends on. The basic components in the milk are water, solids, lactose, FAT, proteins, minerals (salts) and acids. The freezing point depends only on the diluted in the milk components and quantity of the solvent (in the milk it is water). The ultrasonic technology allows direct measurement of FAT, proteins, lactose + salts (the soluble components, only influencing the freezing point), and the quantity of the solvent in % is determined by $100\% - \text{total solids \%}$, $\text{total solids} = \text{lactose \%} + \text{FAT \%} + \text{proteins \%} + \text{salts \%} + \text{acids \%}$.

Without understanding the meaning of the freezing point – determined or shown from the milk analyser added water result easily may lead to a mistake for the value of this parameter.

2. The basic freezing point.

Milk freezes at lower temperature than water. The average freezing point of the raw milk in the most regions is at about $-0,540^{\circ}\text{C}$. The average reading for your region is called “basic” freezing point.

The freezing point of milk is a “physiological constant”. This does not mean that it will not vary. In fact feed, breed, season, time of lactation, climate, whether the sample is taken at the beginning, middle or end of lactation – all these factors will have an effect on the freezing point of the individual sample. This means that there is an average value of all these numbers. The more samples used in obtaining this average, the more reliable it is as a base. Or the basic freezing point is an average of freezing points of milk, taken from many cows. When a laboratory checks a producer, it is only comparing the average of the producer’s cows against a larger area average.

The Health authorities establish the basic freezing point or agriculture departments in some regions, sometimes by universities, separate dairy producers, or their associations. Frequently, tolerances have been established on top of a basic freezing point to allow some variations in the milk as well as device or operator variations.

Without mentioning the basic freezing point, the Association of Official Analytical Chemists now recommends an upper limit freezing point at $-0,525^{\circ}\text{C}$ (2,326 standard deviations above the most recently determined North American average of $-0,5404^{\circ}\text{C}$), below which there will be at 95%

confidence that will show 99% of all freezing point determinations on milk without added water:

“if the freezing point is $-0,525^{\circ}\text{C}$ or below, milk may be presumed to be free of water or may be confirmed as water free by tests, specified below. If the freezing point is above $-0,525^{\circ}\text{C}$, milk will be designated as “presumptive added water” and will be confirmed as added water or added water free by tests specified below. Evaluate extreme daily fluctuations in the freezing point of herd, pooled herd, or processed milk for presence of added water”.

“Presumed added water”, as described above, must be “confirmed” by means of tests on authentic milk samples obtained as specified in the AOAC METHODS.

After determination the freezing point of your sample via the milk analyser, the added water is calculated using the following formula:

$$\text{AddedWater} = \frac{\text{FrPoint}_{\text{Base}} - \text{FrPoint}_{\text{Calc}}}{\text{FrPoint}_{\text{Base}}} * 100[\%]$$

Where:

FrPointBase is the basic freezing point

FrPointCalc is measured freezing point

Note:

If the freezing point is not correctly determined, the result for the added water is not valid. In this case results for FrPoint and AddWater are not shown on the display and on the printout from the printer. If the density of the measured sample is 0, the result for AddWater is not valid and is also not shown on the display and the printouts.

Sample:

First variant

If you've entered for milk analyser basic freezing point -0.520°C (according article 5.9 of the EU Milk Hygiene Directive 92/46/EEC), measured freezing point -0.540°C , using the above pointed formula you'll receive $-3,8\%$. Because it is not possible the added water to be negative value, the milk analyser indicates 0% added water. The reason for this is the tolerance in the basic freezing point, reasons for which are described below.

If in the same milk we add 3,8% water, and the basic freezing point is the same, the milk analyser will measure freezing point -0.520°C , and will indicate again 0% added water.

Second variant

If you've entered for the device basic freezing point -0.540°C , measured freezing point -0.540°C , the milk analyser will indicate 0%. When you add 3,8% water, the device will indicate 3,8%-added water.

From the above mentioned follows that it is very important to enter correct basic freezing point in the device.



The device's results for added water may give information about doubt of added water in the milk and the exact value of this added water may be determined after a "cowshed sample" is taken and the result for the freezing point, measured by the milk analyser of the "cowshed sample" is entered as basic freezing point in the formula for calculation of added water.

Then the result from this formula will give us the absolute value of the added water for the corresponding milk supplier.

APPENDIX 7 PH MEASURING (ONLY FOR DEVICES WITH EMBEDDED FUNCTION)

1. General information

PH probe is a unit, measuring the solution acidity or alkalinity degree. It is measured on scale of 0 to 14. The term pH is derived from "p", the mathematical symbol for the negative logarithm, and "H", the chemical symbol of Hydrogen. The formal definition of pH is the negative logarithm of the Hydrogen ion activity.

2. pH Electrode

For pH measurement the milk analyser needs a combination electrode, compatible with most pH electrodes that have BNC connectors and zero potential (the pH where the mill volt output of the electrode equals 0) near 7 pH.

2.1. Electrode part

The electrode is the most important part of the pH measurement. The electrode glass membrane is fragile and must be handled with care. To protect the glass membrane and to maintain activation, a protective rubber cap containing a suitable storage solution covers the glass membrane.

2.2. Electrode care & Electrode maintenance

pH Electrodes are susceptible to dirt and contamination and need to be clean regularly depending on the extent and condition of use. At no time should one touch or rub the glass bulb as this causes the build-up of electrostatic charge.

2.3. Storage

For best results, always keep the pH bulb wet. An optimal storage solution for combination electrode is pH 4 buffer with 225 grams of KCl per liter. Table salt, NaCl, can be used if KCl is not really available. Other pH buffers or tap water are also acceptable storage media, but avoid storage in de-ionized water. The protective rubber cap filled with the buffer solution provides ideal storage for long periods.

2.4. After Use

After measurement is completed, follow the sequence below for storage.

- Wash the electrode and reference junction in de-ionized water.
- Close the refilling hole by returning its rubber sleeve or stopper cap. (Necessary for only refillable electrode).

- Store the electrode as mentioned above (see section Storage).

2.5. Electrolyte Replacement (for refillable electrode only).

The reference electrolyte needs to be refilled when the electrode has been used for a long period, or when the internal electrolyte has dried up. To accomplish this, follow the procedure described below.

- Remove the protective rubber cap or sleeve;
- Remove the protective rubber sleeve to expose the filling port of the electrode;
- Remove the old reference electrolyte with a syringe;
- Fill the new reference electrolyte.

2.6. New electrolyte preparation:

- Open the KCl container;
- Add in de-ionized water until it reaches the level of 20 ml;
- Close the container and shake it to dissolve the KCl;
- Add in fresh electrolyte until it reaches the level of the refilling port. The reference electrolyte used should be 3M(Mol) KCl;
- Replace the rubber sleeve.

2.7. Re-use the electrode.

- Rinse the liquid junction with de-ionized water.



If these steps fail to restore normal electrode response, you may attempt to rejuvenate it (See: Electrode Rejuvenation).

2.8. Electrode cleaning

Electrodes which are mechanically intact can often be restored to normal performance by one or combination of the following procedures.

- Salt deposits:

Dissolve the deposit by immersing the electrode in tap water for ten to fifteen minutes. Then thoroughly rinse with de-ionized water. Wash the electrode pH bulb in a little detergent and water. Rinse electrode tip in with de-ionized water.

- Oil/Grease films:

Wash electrode pH bulb in a little detergent and water. Rinse electrode tip with de-ionized water.

- Clogged Reference Junction:

pH electrodes have junction, which allows the internal fill solution of the measuring electrode to leak out into the solution being measured. The

junction can become clogged by contamination in the solution. If a clogged junction is suspected it is best to clear the junction.

Heat up the diluted KCl solution to 60-80°C. Place the sensing part of the pH electrode into the heated KCl solution for approximately 10 minutes. Allow the electrode to cool while immersed in some unheated KCl solution.

- Protein Deposits

Prepare 1% pepsin solution in 0.1 M HCl. Allow the electrode to stand in this solution for five to ten minutes. Rinse the electrode with de-ionized water.

2.9. Electrode activation

Generally, if the procedure of storage and maintenance had been closely followed, the electrode can

be used immediately. However, should the electrode response become sluggish, it may be possible that the bulb has dehydrated.

The bulb can be dehydrated by immersing the electrode in an ideal storage solution (e.g. buffer pH 4 solution) for 1-2 hours. If this fails, the electrode may require re-activation. If the above procedure does not reactivate the electrode to acceptable status, try rejuvenation the electrode by following the procedure outlined below.

2.10. Rejuvenation Procedure

Dip and stir the electrode in freon or alcohol for 5 minutes.

Leave the electrode in tap water for 15 minutes.

Dip and stir the electrode in concentrated acid (HCl, H₂S₄) for 5 minutes.

Leave the electrode in tap water for 15 minutes.

Dip and stir in strong base (NaOH) for 5 minutes.

Leave the electrode in tap water for 15 minutes.

Test with standard calibration solution.

Finally, test with standard calibration buffer solution to see if the electrode yields acceptable results. You may repeat again for better response (maximum 3 times). If the response does not improve, then the electrode has completed its useful life. Replace with a new electrode.

2.11. Electrode Lifespan

pH electrodes have a finite lifespan due to their inherent properties. How long a pH electrode will last will depend on how it is cared and the solution it is used to measure. Even if an electrode is not used it still ages. Electrode demise can usually be characterized by a sluggish response, erratic readings or a reading, which will not change. When this occurs an electrode can no longer be calibrated. pH electrodes are fragile and have a limited lifespan.

How long an electrode will last is determined by how well it is maintained and the pH application. The harsher the system, the shorter the lifespan. For this reason it is always a good idea to have a back-up electrode on hand to avoid any system down time.

3. Buffer Solutions

Buffers are solutions that have constant pH values and the ability to resist changes in that pH level. They are used to calibrate pH measurement system.

PH buffer solution description (Pharmacopoeia standard)

Use only these types' standard buffers for calibration!

Description	pH 7.00±0,01/20°C	pH 4.00±0,01/20°C
Composition	Potassium dihydrogen phosphate, Di-sodium hydrogen phosphate	Borax, Sodium hydroxide solution
Temperature parameters	10°C - 7.06 25°C - 6.99 20°C - 7.00 30°C - 6.98 40°C - 6.95 50°C - 6.91	10°C - 4.00 25°C - 4.00 20°C - 4.00 30°C - 4.00 40°C - 4.00 50°C - 4.05

4. pH Electrode Calibration

pH Electrodes are like batteries; they run down with time and use. As an electrode ages, its glass changes resistance. For this reason, electrodes need to be calibrated on a regular basis. Calibration in pH buffer solution corrects for this change.

Calibration is an important part of electrode maintenance. This assures not only that the electrode is behaving properly but that the system is operating correctly.

Usually pH meters require calibration at 2 specific pH values. One calibration is usually performed at pH 7, second pH 5.



It is the best to select a buffer as close as possible to the actual pH value of the sample to be measured. Use standard calibration buffers that the temperature and the sample solution are the same.

Use the operation manual for the corresponding pH meter.

For pH electrodes, originally supplied with milk analyser read the following information:

Temperature compensations

The output of pH electrodes varies with temperature in manner, predicted by theory. When needed, Sensorex can supply electrode holders with build-in automatic temperature compensators. The need of automatic compensation depends on the temperature variation, the pH value being measured. At pH of about 7 there is no error due to temperature and, of course, at a constant temperature there is no error. As shown in the following table, the pH error due to temperature is a function of both the temperature and the pH value being measured. At a pH of about 7 there is no error due to temperature and, of course, at a constant temperature there is no error. The more the temperature changes from the ambient calibration temperature and the more the pH departs from 7 the greater is the pH error.

pH temperature error table

°C	pH										
	2	3	4	5	6	7	8	9	10	11	12
5	.30	.24	.18	.12	.06	0	.06	.12	.18	.24	.30
15	.15	.12	.09	.06	.03	0	.03	.06	.09	.12	.15
25	0	0	0	0	0	0	0	0	0		0
35	.15	.12	.09	.06	.03	0	.03	.06	.09	.12	.15
45	.30	.24	.18	.12	.06	0	.06	.12	.18	.24	.30
55	.45	.36	.27	.18	.09	0	.09	.18	.27	.36	.45
65	.60	.48	.36	.24	.12	0	.12	.24	.36	.48	.60
75	.75	.60	.45	.30	.15	0	.15	.30	.45	.60	.75
85	.90	.72	.54	.36	.18	0	.18	.36	.54	.72	.90

0 pH Error Range

Less than .1 pH Error Range

5. PH helpful hints

For greatest accuracy in pH measurement, follow these guidelines:

- Use the same technique to measure samples, which was used for calibration.
- Be consistent with stirring rates, times and conditions.
- Calibrate with buffers, which are close in temperature to that of the sample.
- Calibrate the pH electrode regularly, e.g. once a day for accuracy to within 0.05 pH.

- Use fresh buffers for calibrations. Avoid contamination of the stock buffer solution and do not use it beyond the expiry date.
- Keep all connections dry.
- Immerse the electrode far enough into the solution to insure the reference junction is below the surface.
- Allow adequate time for the electrode to stabilize in standards and samples before taking a reading.
- Clean the electrode periodically. Allow more time for aged electrodes.
- Do not use the pH electrode in solutions of fluoride ion at low pH. This will etch the glass membrane.
- Sulphide vapors can permeate the electrode wick and contaminate the reference element. Minimize contact in such environments and change the reference electrolyte frequently.

Milk acidity and pH

In the table below the connection between pH value and acidity in °T is shown

°T	deviation	pH average value	°T	deviation	pH average value
Raw milk			Pasteurized milk		
16	6,74-6,70	6,72	16	6,68-6,64	6,66
17	6,69-6,65	6,68	17	6,63-6,58	6,61
18	6,64-6,58	6,62	18	6,57-6,52	6,55
19	6,57-6,52	6,55	19	6,51-6,46	6,49
20	6,51-6,46	6,49	20	6,45-6,40	6,43
21	6,45-6,40	6,43	21	6,39-6,35	6,37
22	6,39-6,35	6,37	22	6,34-6,30	6,32
23	6,34-6,30	6,32	23	6,29-6,24	6,26
24	6,29-6,24	6,25	24	6,23-6,19	6,21

6. Replacing the pH electrode

Fig. 10 pH sensor and holder assembly

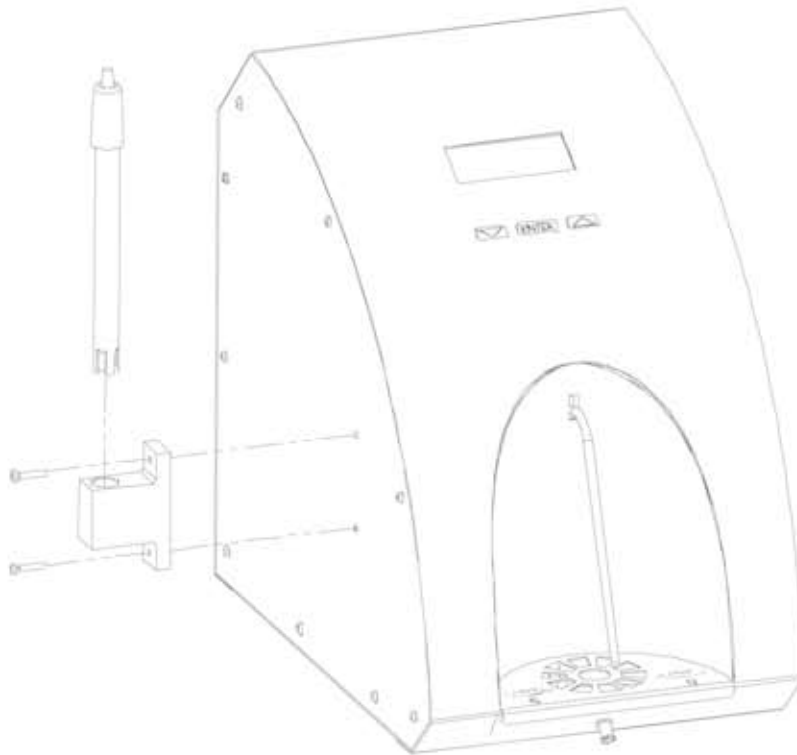

During transportation the pH sensor holder and sensor itself are packed separately. In order to place it in working position, follow the sequence:

1. Using the screws, attach the pH sensor holder on the side of the analyser as shown on Fig. 11.
2. Tighten the screws.
3. Put the electrode in the holder.

Follow the instructions for pH measuring.

7. PH measuring.

Measuring pH is an additional feature of the analyser and is optional. Remove the protective rubber cap of the pH electrode. Take care to handle it appropriately in order not to be damaged. Use de-ionized or distilled water to rinse the electrode before usage. Fill in the sample holder with milk, put it in the recess of the analyser and dip the pH electrode into the milk sample, ensuring complete dip of the electrode in the sample. Stir gently for homogenization of the sample.

Measuring can be done in two modes:

Off line by starting the menu **pH & Co Meter | Measuring**, when the analyser works only as a pH meter.

On line automatic pH measuring, when measuring the rest of the sample's parameters.



When starting work with pH meter first connect the probe/sensor, and then the power supply of the device.

Having in mind the characteristics of the process of pH measuring it is necessary to dip the pH probe in the sample and then to press the button Enter.

pH probe is knee-joint (mobile) and is adjusted towards the input pipe of the analyser.

Move them forward in order to be possible to dip probes' end in the milk sample and place the sample holder in the recess of the analyser.

After starting the menu **pH & Co Meter** the following message appears on the display:

```

pH Calibration
pH Measuring
pH En/Disable
pH U Display
-----
pH Test
Co Meter Calibr
Co Meter Test
Co Meter En/Dis
-----
Exit
    
```

8. pH Calibration.

Serves for calibrating the pH meter. For that purpose use 2 standard buffers, shown on the display as Low buffer (for example 5.00 pH) and High buffer (for example 7.00 pH). The procedure is following:

1. Start menu **Calibration**.
2. Put the pH probe in Low buffer.
3. By pressing the buttons of the analyser enter the exact buffer value. The display shows:

```

pH Calibr
Put Izopot buff
Buf=xx.xxx
    
```

4. Input the buffer value when the probe is in its isopotential point and with which our probes are accompanied with.

Then the display shows:

```

pH Calibr
Put Izopot buff
Buf=xx.xxx
V=x.xxxV Set
    
```

Where **x.xxx** is measured by the probe voltage.

5. After the readings calm down, the operator has to press the button below the inscription **Set**.

6. Repeat the procedure with **Next buffer**.

The following is displayed:

pH Calibr OK

This means that the procedure for analyser calibration was successfully completed.

7. pH measuring mode is started automatically.

8. Check calibration correctness by measuring buffer solution 7.00.

9. pH Measuring.

After starting this menu the measurement is done in mode off line, i.e. the analyser works only as a pH meter. The operator has to dip the probe in the sample and on the display the following is shown:

**pH measuring
x.xxxV
y.yy pH
Exit**

Where:

x.xxx – measured by the probe voltage

y.yyy – measured probe's pH

By pressing the button **Exit**, the operator may exit the program and to pass towards another menu.

10. pH En/Disable

Serves for enabling/disabling the pH measuring during normal work of the analyser - On line. After starting it the display shows:

**pH Measuring
XXX
No OK Yes**

Where **XXX** is the current situation of the working mode. By pressing the buttons below the corresponding inscriptions it could be changed, as **Yes** – means that during normal work of the analyser – measuring the rest of the parameters, pH will also be measured. If **No** is chosen, then pH is not measured.

11. pH U Display

Serves for allowing/forbidding the value of the pH probe voltage during pH parameter measuring. After starting it the display shows:

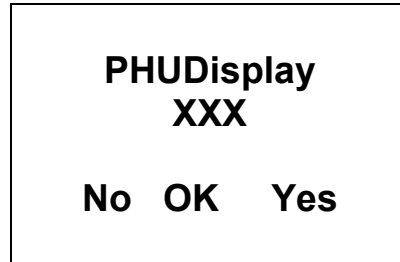

Where **XXX** is the current state of the displaying mode. By pressing the buttons below the inscriptions it could be changed, as **Yes** – means that during pH measuring the voltage of the pH probe will be shown.

If **No** is chosen, it will not be shown. It refers to both of the measuring modes.

12. pH test

serves for testing the measuring system in production mode.

APPENDIX 8 CONDUCTIVITY MEASURING (ONLY FOR DEVICES WITH EMBEDDED FUNCTION)

1. Method of determination.

Conductivity (or Electrolytic Conductivity) is defined as the ability of a substance to conduct electrical current. It is the reciprocal of the resistance.

In a healthy animal*, the mean value of electric conductivity is:

Milk type	Conductivity values
Cow milk	between 4 to 6 mS/cm (18°C);
Sheep milk	between 3 to 5 mS/cm (18°C);
Buffalo	between 2,5 to 5 mS/cm (18°C);

*These values depend on the geographical region, the breed and on other factors.

Milk conductivity changes on the concentration of ions in the milk:

Added water, sugar, proteins, insoluble solids	Decrease the ion's concentration. Milk conductivity decreases.
Added salts	Increase the ion's concentration. Milk conductivity increases. Often the milk is falsified by adding salt: towards milk with good characteristics: fat 4%, SNF 8,8, conductivity 4,5 are added salt and water. Then the results are changed to 3,2 and 8,8, conductivity 10. In other words adding water regulates the increased value of SNF and density till normal (within the boundaries/parameters) and even the fat is normal. By the values of these parameters may be determined if the sample is falsified, but the only characteristic, proving this is conductivity, which is out of boundaries nevertheless added water. But be careful, as the falsification is not the only possible reason for conductivity increasing. The other possibility is mastitis that's why we recommend using another (chemical) method for checking it.
Significantly extreme value (6,5 - 13,00 mS/cm (18°C))	Should indicate the development of mastitis. Infections damage the tissue of the udder. This allows sodium and chlorine ions from the blood to

	be released into the milk. The concentration of ions in the milk is thereby raised, and it can more easily conduct an electrical current - the conductivity of the milk increases.
--	--

Milk conductivity can be used as tests for degree of water evaporation in condense milk production.

Milk conductivity change notifies of powder (dry) milk solution rate.

2. Conductivity measurement

Conductivity measurement is additional possibility of the analyser and is delivered on customers request/

3. Co Meter Calibr

Serves for conductivity measuring system calibration. Clean the analyser before starting conductivity measurement. (see p. 4.1). You need a standard buffer with conductivity 5.02[mS/cm] (you may order it for delivery together with the analyser), with temperature 18°C. After starting this mode, the analyser makes preparation for measurement and when it is ready, the following message is displayed:

<p>Co Meter Cal Put 5.02 buff and press Enter to start</p>

The operator has to put the buffer and to start the measurement. The following message appears on the display:

<p>Measurement started Wait please</p>

The buffers' temperature is indicated during measurement. After finishing the measurement the following message appears on the display:

**Co Pass 1/5=xxxx
Put new sample
and press Enter
to start**

Where xxxx is the result from the first calibration measurement. The operator have to put a new buffer, N.B. do not use one and the same buffer more than once! Then start the next measurement. This procedure has to be repeated 5 times. At the end the following message appears on the display:

**Cond Meter
Calibr= xxxx
Switch Off/On**

Now the operator has to switch off the power supply of the analyser. After switching it on again, the analyser has to be cleaned again with water, which ends the calibration of the conductivity measurement system calibration.

Note:

Another possibility for calibration of analyzer's conductivity measurement function.

You need conductivity meter. First measure milk with normal acidity with conductivity meter and use it as sample for calibrating the analysers conductivity measurement function.

4. Co Meter Test.

Serves for testing the working mode of the milk's sample conductivity measurement system. It is used in the production conditions. After this menu is chosen, the analyser executes the procedure for sample's measurement and the display shows the data, used for obtaining the samples conductivity.

**Co Meter Test
CoADC= xxxx
Power Off - Stop**

5. Co Meter En/Dis.

Enables or disables the conductivity measurement system. The following message appears on the display:

Cond Measuring
Yes

No OK
Yes

6. Corrections in conductivity measurement

It is done by starting the menu **Corrections -> Cond measure**. You have the possibility to increase/decrease the measured conductivity value from – 1.00 till +1.00, with step 0.01. After starting this function the display shows the following:

Con Meter
-1.0<=Corr>=1.0
Co Corr=+0.00
Edit – Up/Down

The cursor is positioned below the +. By using buttons **Up/Down**, the operator has the possibility to change the value (number). By pressing the button **Enter**, the operator confirms the chosen value and moves to the next position for editing it. After the last position is edited, if the correction value is within allowed boundaries, the following is displayed: **Co Corr Saved**, which means, that the correction is entered and saved. On the contrary – it returns at the beginning and expects valid correction.

7. Conductivity calibration buffer preparation

In order a standard buffer for conductivity measuring to be prepared follow the instruction below:

1. Take the packet with the powder buffer.
2. Carefully shake the packet in order to gather the powder at the bottom.
3. Cut one end of the packet.
4. Empty its content in a measuring mug with 1 l volume, paying attention all its content to be emptied.

For standard buffer: 5,02 ms – 3,556 г

5. Add 600-700 ml distilled water, which was preliminarily deaerated in vacuum dryer or boiled and then cooled down to 20 °C.
6. Shake the mug till the powder is fully dissolved.
7. Add distilled water to the mark.

Contents:

1. FUNCTION	5
2. TECHNICAL PARAMETERS	6
2.1. WORKING MODES CHARACTERISTICS:	6
2.1.1. MEASUREMENT MODE MILK / DAIRY PRODUCT – FIRST TYPE	6
2.1.2. MEASUREMENT MODE MILK / DAIRY PRODUCT – SECOND TYPE	6
2.1.3. MEASUREMENT MODE MILK / DAIRY PRODUCT – THIRD TYPE	6
2.1.4. CLEANING.....	6
2.2. MEASURING RANGE:	7
2.3. ACCURACY:	8
2.4 CORRECT AMBIENT CONDITIONS:	8
2.5. DIMENSIONS:	8
2.6. CONTINUOUS WORKING TIME:	8
2.7 MILK SAMPLE VOLUME PER ONE MEASUREMENT:	8
3. QUALIFICATION OF RAW MILK, THERMALLY TREATED MILK, OTHER DAIRY PRODUCTS AND DERIVATIVES	14
3.1. TAKING SAMPLES AND PREPARATION FOR ANALYSES	14
3.2. MAKING THE MEASUREMENT	14
3.2.1. PREPARING THE ANALYSER FOR WORKING MODE	14
3.2.2. MAKING ANALYSES	15
3.2.3. DISPLAYING THE RESULTS	16
4. CLEANING THE ANALYSER	19
4.1. AUTOMATIC CLEANING THE ANALYSER	19
4.1.1. CURRENT CLEANING.	20
4.1.2. END (FINAL) CLEANING.....	22
4.2. PREPARATION OF CLEANING SOLUTION	25
4.2.1. PREPARATION OF ALKALINE CLEANING SOLUTION.....	25
4.2.2. PREPARATION OF ACIDIC CLEANING SOLUTION.....	25
4.3. WORKING WITH THE PERISTALTIC PUMPS	25
4.3. WORKING WITH THE PERISTALTIC PUMPS	26
5. POSSIBLE MALFUNCTIONS AND ERROR MESSAGES, TROUBLESHOOTING	28
6. MAKING CORRECTIONS AND RECALIBRATION OF THE DEVICE	29
6.1. TAKING SAMPLES AND PREPARATION OF SAMPLES FOR CHECKING THE ACCURACY OF THE MILK ANALYSER, MAKING CORRECTIONS AND RECALIBRATION	29
6.2. DETERMINATION THE TYPE OF THE DISCREPANCY:	29
6.2.1. MAKING MEASUREMENTS	29
6.2.2. ANALYZING THE MEASUREMENT RESULTS.....	29

6.3. MAKING CORRECTIONS	30
6.3.1. POSSIBLE CORRECTIONS, LIMITS AND CHANGING STEPS	30
6.3.2. PREPARING THE ANALYSER FOR MODE CORRECTIONS	30
6.3.3. MAKING CORRECTION.....	31
6.4. RECALIBRATING THE MILK ANALYSER.....	33
6.4.1. RUNNING THE ANALYSER IN MODE RECALIBRATE	33
6.4.2. MAKING RECALIBRATION	34
7. STARTING THE DEVICE IN A SERVICE TEST/SETUP OPERATIONAL MODE. MENUS DESIGNATION.....	39
7.1. STARTING THE DEVICE IN A SERVICE TEST/SETUP OPERATIONAL MODE.....	39
7.2. MENUS FUNCTION:	40
7.2.1. SPECIAL MODES.	40
7.2.2. CORRECTIONS.....	40
7.2.3. SETTINGS.....	41
7.2.4. TESTS.....	47
7.2.5. PH METER & CO METER	47
7.2.6. EXIT.....	47
7.2.7. SUMMARY OF MILK ANALYSER SETUP FUNCTIONS	48
8. ADDITIONAL POSSIBILITIES OF THE ANALYSER.....	51
8.1. CONNECTING TO 12 V DC POWER SUPPLY.....	51
8.2. CONNECTING TO IBM PC.....	51
8.3. CONNECTING ADDITIONAL SERIAL PRINTER (OPTION).....	51
8.4. CONNECTING MATRIX PRINTER (OPTION).....	51
8.5. CONNECTING AND WORKING WITH EXTERNAL KEYPAD (OPTION).	51
8.6. MEASURING HIGH FAT SAMPLES (OPTION).....	53
8.7. WORKING WITH EMBEDDED ACCUMULATOR (OPTION).....	54
8.8. EMBEDDED REAL TIME CLOCK (OPTION).	55
APPENDICES	57
APPENDIX 1 METHODS	57
1. DETERMINATION OF MILK'S DENSITY.....	57
1.1. GENERAL	57
1.2. SAMPLING AND PREPARATION FOR ANALYSES	57
1.3. BASIC PRINCIPLES.....	57
1.4. NECESSARY DEVICES AND REAGENTS.....	57
1.5. MAKING THE DETERMINATION:	57
1.6. RECALCULATING THE VALUES ACCORDING LACTO-DENSITY-METER AT 20 OC.....	58
2. DETERMINATION OF FAT CONTENT IN THE MILK AND MILK DERIVATIVES.	58
2.1. GENERAL	58

2.2. SAMPLING.....	58
2.3. BASIC PRINCIPLES.....	58
2.4. NECESSARY DEVICES AND REAGENTS.....	58
2.5. MAKING THE DETERMINATION:	59
2.6. MAKING MEASUREMENT	59
2.7. CALCULATING THE RESULTS.....	59
2.8. MEASUREMENT ACCURACY	60
3. DETERMINATION OF WATER CONTENT AND SOLIDS IN THE MILK AND MILK DERIVATIVES..	60
3.1. GENERAL	60
3.2. BASIC PRINCIPLES.....	60
3.3. NECESSARY DEVICES AND REAGENTS.....	60
3.4. MAKING THE DETERMINATION:	61
3.5. MAKING THE MEASUREMENT.....	61
3.6. CALCULATING THE RESULTS.....	61
3.7. MEASUREMENT ACCURACY.	61
4. DETERMINATION OF CASEIN CONTENT IN THE MILK.	62
4.1. GENERAL	62
4.2. SAMPLING.....	62
4.3. BASIC PRINCIPLES.....	62
4.4. NECESSARY DEVICES AND REAGENTS.....	62
4.5. MAKING THE DETERMINATION:	62
4.6. MAKING THE MEASUREMENT.....	62
4.7. CALCULATIONS	63
4.8. MEASUREMENT ACCURACY.	64
5. DETERMINATION OF SALTS IN THE MILK	64
5.1. GENERAL	64
5.2. SAMPLING.....	64
5.3. BASIC PRINCIPLES.....	65
5.4. NECESSARY DEVICES AND REAGENTS.....	65
5.5. MAKING THE DETERMINATION:	65

5.6. CALCULATIONS	65
5.7. MEASUREMENT ACCURACY	65
APPENDIX 2 REPRESENTATIVE SAMPLES FROM MILK AND OTHER MILK DERIVATIVES FOR MILK ANALYSER'S CALIBRATION	66
1. GENERAL	66
2. NECESSARY QUALITY PARAMETERS VALUES DETERMINATION	66
2.1. LABORATORY METHODS	66
2.1.1. DETERMINATION OF FAT CONTENT	66
2.1.2. MILK DENSITY DETERMINATION	67
2.1.3. DETERMINATION OF TOTAL PROTEINS.....	67
2.1.4. DETERMINATION OF CASEIN CONTENT IN THE MILK	68
2.1.5. DETERMINATION OF SALTS IN MILK.	68
2.1.6. DETERMINATION OF SOLIDS IN MILK.....	68
2.2. EXPRESS METHODS BY USING ANOTHER MILK ANALYSERS	68
APPENDIX 3 MILK SAMPLING AND PREPARATION OF SAMPLES FOR ANALYSES.....	69
1. GENERAL	69
2. STIRRING THE MILK AND ITS DERIVATIVES BEFORE SAMPLING	69
3. SAMPLING.....	70
4. SAMPLE PRESERVATION.....	70
5. PREPARING THE SAMPLES FOR ANALYSES.....	70
APPENDIX 4 SAMPLING AND PREPARATION OF SAMPLES FOR VERIFICATION THE ACCURACY OF THE MILK ANALYSER, MAKING CORRECTIONS AND RECALIBRATION.....	72
1. NECESSARY CONSUMABLES AND DEVICES	72
2. GENERAL	72
3. REPRESENTATIVE SAMPLES	72
4. SAMPLES PREPARATION	74
5. ADVISABLE SCHEME FOR INDEPENDENTLY DETERMINATION THE CONTENT OF DIFFERENT PARAMETERS IN MILK AND ITS DERIVATIVES.....	75
5.1. FOR COW MILK (WHOLE MILK, LOW FAT, SKIMMED MILK) AND UHT MILK.....	76
5.2. FOR SHEEP MILK.....	77
5.3. FOR WHEAT, BUTTERMILK AND CREAM	78
APPENDIX 5: EASY CALIBRATION OF THE MILK ANALYSER BY CALCULATING THE BASIC PARAMETERS VIA FORMULAS	79
5.1. DETERMINATION SOME OF THE PARAMETERS BY FORMULAS.....	79
5.2. SNF DETERMINATION.	79
5.3. DETERMINATION OF LACTOSE CONTENT	80
5.4. DETERMINATION OF SALTS CONTENT.....	80
5.5. DETERMINATION OF TOTAL PROTEINS CONTENT	81
APPENDIX 6 FREEZING POINT DETERMINATION	82
1. METHODS FOR DETERMINATION.	82
2. THE BASIC FREEZING POINT.	82
APPENDIX 7 PH MEASURING (ONLY FOR DEVICES WITH EMBEDDED FUNCTION).....	85
1. GENERAL INFORMATION	85
2. PH ELECTRODE.....	85
2.1. ELECTRODE PART	85
2.2. ELECTRODE CARE & ELECTRODE MAINTENANCE	85

2.3. STORAGE.....	85
2.4. AFTER USE.....	85
2.5. ELECTROLYTE REPLACEMENT (FOR REFILLABLE ELECTRODE ONLY).....	86
2.6. NEW ELECTROLYTE PREPARATION:.....	86
2.7. RE-USE THE ELECTRODE.	86
2.8. ELECTRODE CLEANING.....	86
2.9. ELECTRODE ACTIVATION	87
2.10. REJUVENATION PROCEDURE	87
2.11. ELECTRODE LIFESPAN	87
3. BUFFER SOLUTIONS	88
4. PH ELECTRODE CALIBRATION	88
5. PH HELPFUL HINTS	89
6. REPLACING THE PH ELECTRODE.....	91
7. PH MEASURING.....	92
8. <i>pH Calibration.</i>	93
9. <i>pH Measuring.</i>	94
10. <i>pH En/Disable</i>	94
11. <i>pH U Display</i>	95
12. <i>pH test</i>	95
APPENDIX 8 CONDUCTIVITY MEASURING (ONLY FOR DEVICES WITH EMBEDDED FUNCTION)...	96
1. METHOD OF DETERMINATION.....	96
2. CONDUCTIVITY MEASUREMENT.....	97
3. CO METER CALIBR.....	97
4. CO METER TEST.	98
5. CO METER EN/DIS.	98
6.CORRECTIONS IN CONDUCTIVITY MEASUREMENT.....	99
7. CONDUCTIVITY CALIBRATION BUFFER PREPARATION	99
CONTENTS:.....	101

GUARANTEE CARD

MIA-LA

**Guarantee period is 1 (one) year after purchasing date.
Improper handling, transport and storage will invalidate the guarantee.
Guarantee is void if warranty labels are removed.**

Serial №

Date of purchase:

Password:

Distributor:

Signature:

Stamp:

GUARANTEE CARD

Purchaser:

--

Service report:

Service entry date	Damage	Delivery date	Signature

Covers:
MIA-LA, LCD display



MRC LTD -HAGAVISH 3, HOLON ISRAEL
Tel: 972-3-5595252, Fax: 972-3-5594529
E-mail: mrc@mrclab.com ● Web. Site: www.mrclab.com