

# LOCAL EXTRACTOR



## MiniTEX 1100, 1500

**Flexible, telescopic  
local extractor with the  
market's lowest pressure drop.**

The FUMEX local extractor MiniTEX, with lengths of 1.1 m and 1.5 m, is a telescopic local extractor e.g. for laboratories that require a compact extractor with a very low pressure drop.

MiniTEX is equipped with gas springs to balance the weight of the arm. Its adjustable telescopic function, moveable angle joint and 360° swivel, along with the flexible suction unit, gives a local extractor that is both easily moved and has stable positioning. FUMEX always designs its local extractors with external support arms, which ensures a natural and linear airflow. This gives a low pressure drop and a low risk of blockage.

With the special telescopic function, the MiniTEX has a much lower pressure drop than conventional suction arms. Therefore, it is exceptionally suitable when there is a need for a low pressure drop in the extraction system. The MiniTEX can also be equipped with different hoods, which further increase the extraction efficiency.

The joints and telescopic function can be simply adjusted from the outside. The smooth tubes ease internal cleaning of the extraction duct. The arm is supplied complete with an airtight damper. The FUMEX MiniTEX is available in designs for ceiling- or wall mounting.

*Also included in the Fumex range are fans, accessories, automatic controls and filters suitable for the local extractor*

**FUMEX®**  
LOCAL EXTRACTOR

**Pure Advantage**

## The market's lowest pressure drop

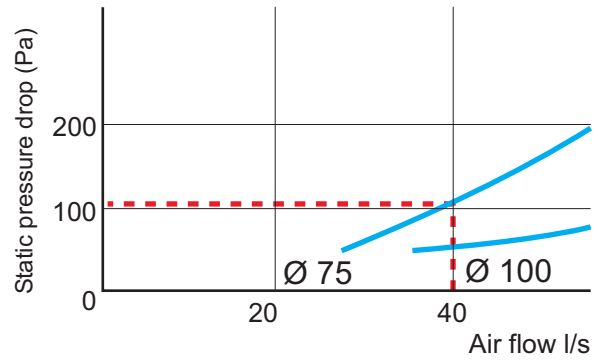
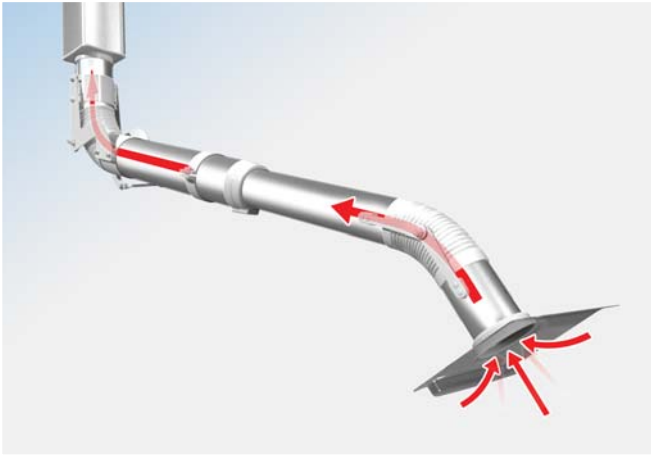

### The low pressure drop gives many benefits

The MiniTEX has a linear airflow, without internal components to obstruct the air stream. At the same time, the telescopic function permits a relatively high air velocity in the suction nozzle.

For most types of laboratories, a diameter of Ø75 mm and an airflow of 40 l/s (150 m<sup>3</sup>/h) is recommended. This airflow provides a sufficiently large air volume to evacuate the air pollutants that arise. MiniTEX, with Ø75 mm, provides a static pressure drop of only 110 Pa at 40 l/s (150 m<sup>3</sup>/h), while at the same time the nozzle air velocity is nearly 10 m/s.

These characteristics give several benefits.

- It is easy to use the MiniTEX in the same ventilation system, for example, as a fume cupboard that also has a very low pressure drop.
- The high nozzle air velocity provides effective capture of pollutants and it is not easily influenced by other disturbing air currents in the area.
- The low pressure drop minimises the risk of noise problems.

## Ideal for low ceilings



### MiniTEX is ideal for low ceilings and low hanging light fittings

The telescopic function, with just one bendable joint, means the extractor is never at risk of collision with low hanging light fittings or low suspended ceilings.

## Neat and stable brackets

MiniTEX is supplied with a stable grip in anodised aluminium with a high finish to obtain a good, functioning extraction.

**MTI-125** Ceiling bracket can be fitted with sleeves both below and above a false ceiling, in the latter case preferably together with MTI CT-125.

**MVK-125** Wall bracket is always included in models with designation MXV.

**MTF-125** Ceiling bracket for fitting through e.g. roof beams. Fixing plate is adjustable along whole length of aluminium tube, if required, aluminium profile can be cut to fit.



## Range and recommended mounting height for MX 1100-75 and MX 1100-100

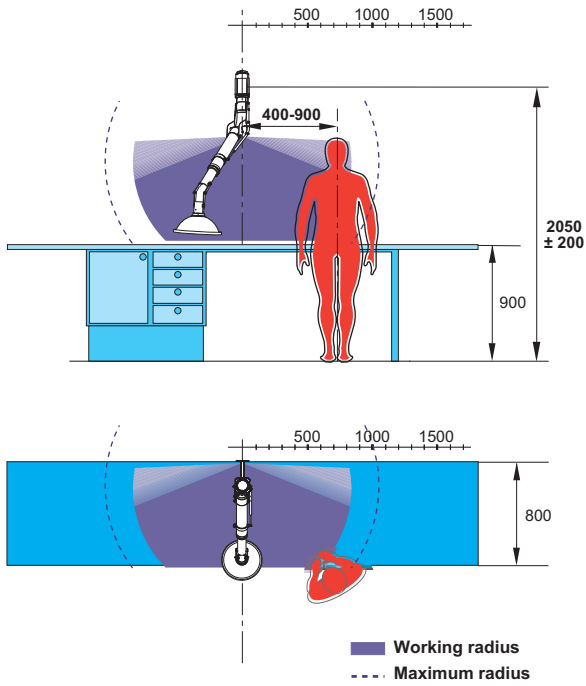

## Range and recommended mounting height for MX 1500-75 and MX 1500-100

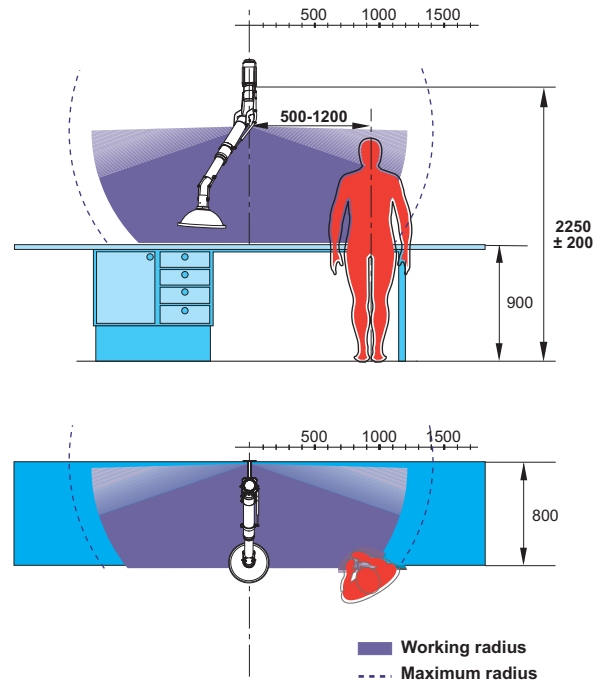

To optimize the usability of the extractor, the above mentioned mounting heights, and sideways displacements from the workplace, are recommended.

## Applicable areas of use

Dimension	Activity
Ø 75 mm	Laboratories, Schools, Science Lecture Rooms
Ø 100 mm	Laboratories, Light Industry - Gluing - Solvents - Hard soldering - Light welding/TIG

## Pressure drop diagram

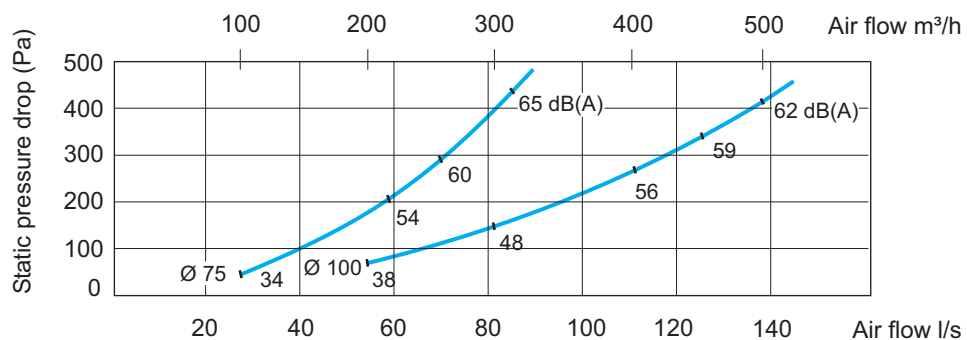

The static pressure drop is measured in accordance with ISO standard 5167-1. The noise level is measured according to ISO standard 3741.

## Ceiling mounting

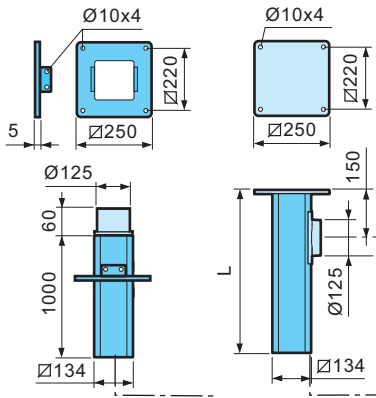

MTF-125

MTI-125

## Wall mounting

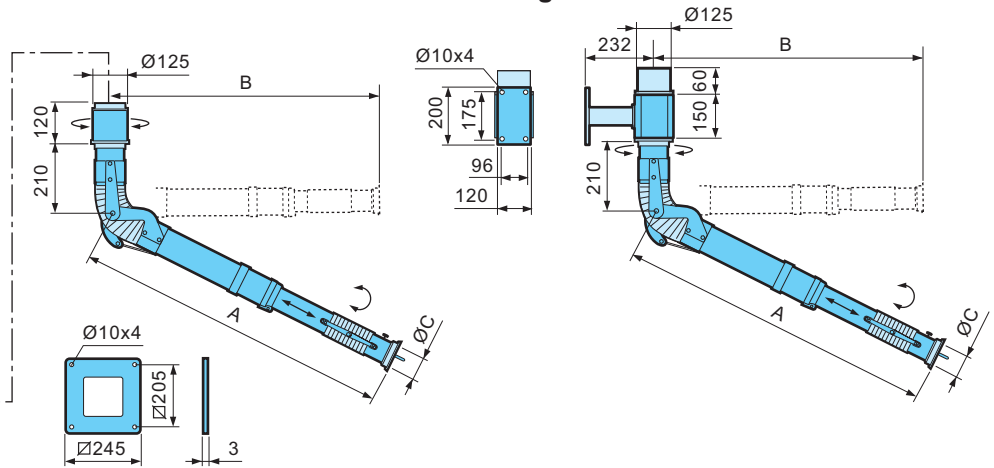

MTI CT-125

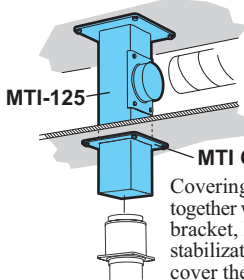

MTI-125  
MTI CT-125  
Covering plate, used together with the ceiling bracket, MTI, for stabilization and also to cover the hole through the false ceiling.

Ceiling mounting	L (mm)	Weight (kg)
MTI 500-125	500	4,90
MTI 750-125	750	5,80
MTI 1000-125	1000	6,75
MTI 1250-125	1250	7,65
MTI 1500-125	1500	8,60
MTI 1750-125	1750	9,50
MTI 2000-125	2000	10,40
Ceiling mounting	L (mm)	Weight (kg)
MTF 1000-125	1000	6,50

Designation	A(mm)	B(mm)	Ø C(mm)	Weight (kg)
Ceiling mounting				
MXT 1100-75	1100	800	75	4,6*
MXT 1500-75	1500	1000	75	5,3*
MXT 1100-100	1100	800	100	5,8*
MXT 1500-100	1500	1000	100	6,6*
Wall mounting				
MXV 1100-75	1100	800	75	7,2
MXV 1500-75	1500	1000	75	7,9
MXV 1100-100	1100	800	100	8,4
MXV 1500-100	1500	1000	100	9,2

\*weight excluding the ceiling bracket

## Hoods

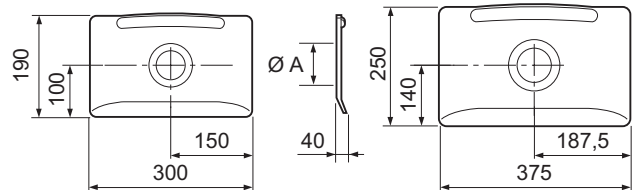
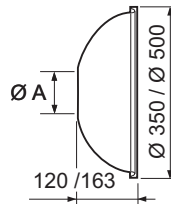
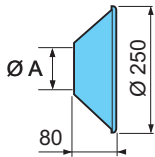

### Metal hood

Designation	ØA(mm)	Weight (g)
MM 250	75	140
MM 251	100	140

The metal hood is used for work in tougher environments.. Capture of hot gases, dust spray, etc.

### Dome hood

Designation	ØA(mm)	Weight (g)
MK 350	75	275
MK 351	100	275
MK 500	100	400

The dome hood is used to cover the source of contamination effectively, without blocking the line of sight. Available in Ø 350mm for MiniTEX 75 and MiniTEX 100. For MiniTEX 100 is also a Ø 500mm dome hood available.

### Flat screen hood

Designation	ØA(mm)	Weight (g)
MPH 300	75	170
MPH 375	100	290

The flat screen hood is designed to maximise the working area without obscuring the object from the user. The flat screen hood provides the best suction power for work on tables and benches.

## Materials

### Ducts and profiles

Manufactured in thin-walled anodised aluminium.

### Hose

Spring-steel coil completely enclosed in PVC coated polyamide fabric. Flame resistant, suitable for many chemicals. Temperature range -30°C to +100°C. For other qualities of hose, please contact Fumex.

### Metal components

Manufactured of powder-coated plate steel.

### Plastic components

Manufactured of polypropylene.

### Hoods

Hoods MK and MPH are manufactured in transparent PETG. MM hoods are manufactured in coated aluminium.

## Delivery description

The arm is supplied complete with an airtight damper. The arm for wall mounting is supplied complete with wall bracket.

For ceiling mounting, ceiling bracket MTI is ordered separately. Metal-, dome- and flat screen hoods are available as accessories.

# FUMEX®

Verkstadsvägen 2, SE-931 61 SKELLEFTEÅ, SWEDEN  
+46 910 361 80, Fax +46 910 130 22  
www.fumex.com e-mail: info@fumex.se